

# FISH HABITAT MANAGEMENT FOR PENNSYLVANIA IMPOUNDMENTS

# 2007

David E. Houser



[www.fish.state.pa.us](http://www.fish.state.pa.us)

Pennsylvania  
Fish & Boat  
Commission

*Division  
of Habitat  
Management*

*Pennsylvania  
Fish & Boat  
Commission  
“structure boat”  
hauling a recently  
constructed  
porcupine crib to  
be submerged at  
a pre-determined  
site.*



Pennsylvania Fish & Boat Commission fish habitat boats

*The Pennsylvania  
Fish & Boat  
Commission’s  
rubble placement  
barge hauls a  
1-ton load of  
rock rubble in  
a northwest  
Pennsylvania  
impoundment.  
Rock rubble  
provides forage  
habitat.*



# TABLE OF CONTENTS

## PENNSYLVANIA FISH & BOAT COMMISSION DIVISION OF HABITAT MANAGEMENT LAKE SECTION

### Fish Habitat Management for Pennsylvania Impoundments

*by David F. Houser*

#### SECTION ONE

Lake FHI History . . . . .	1
Goals and Objectives . . . . .	3
U.S. Army Corps of Engineers Permit Requirements (Section 404) . . . . .	4
Pennsylvania Department of Environmental Protection (Chapter 105) . . . . .	4
Pennsylvania Fish & Boat Commission Legal Requirements . . . . .	4

#### SECTION TWO

Lakes, Ponds and Reservoirs . . . . .	6
Impoundment Aging . . . . .	7
Environmental Characteristics of Impoundments and Lakes . . . . .	7
Impoundment Production Factors . . . . .	8
Impoundment Fisheries Habitat Requirements . . . . .	10

#### SECTION THREE

Native Habitats . . . . .	12
Natural Habitats (Aquatic Vegetation) . . . . .	12
Artificial Habitats . . . . .	12

#### SECTION FOUR

Impoundment Habitat Management Methods . . . . .	20
Pond Habitat Management Methods . . . . .	21

<b>ACKNOWLEDGMENTS</b> . . . . .	22
----------------------------------	----

#### APPENDICES

Pennsylvania Artificial Habitat Structure Standard Drawings . . . . .	23
Typical Pennsylvania Pond Fish Habitat Plan . . . . .	37
Research Literature . . . . .	38
Habitat Classification for Pennsylvania Impoundments . . . . .	39

**David F. Houser**

Pennsylvania Fish & Boat Commission  
450 Robinson Lane  
Bellefonte, PA 16823  
814-359-5219

E-mail: [dhouser@state.pa.us](mailto:dhouser@state.pa.us)



# SECTION I

## LAKE FHI HISTORY

Although the Pennsylvania Fish & Boat Commission's first official cooperative fish habitat improvement program started in the spring of 1972, the first lake habitat project did not take place until 1979. The Lake Fish Habitat Improvement Program (FHI) in Pennsylvania expanded further in the spring of 1990.

In 1985, the Pennsylvania Fish Commission's Cooperative Habitat Improvement Program, managed by Fisheries Environmental Services staff, conducted improvement projects in a small number of impoundments throughout the Commonwealth. At that time, the goal was to improve fishing through the placement of "fish attraction structures." These attraction devices were primarily constructed of discarded tires and Christmas trees. Volunteers placed most of the fish-attraction devices in drawn-down impoundments. Lake habitat projects normally occurred during the winter months, when vehicles could easily access frozen lake bottoms. In reservoirs where no draw-downs occurred, the structures were sometimes placed on the ice, for submergence in spring, when the ice broke up.

Although the popularity of this program grew (28 approved projects placed 884 structures in 1989), the design techniques of artificial habitats for impoundments changed very little in a decade of FHI in Pennsylvania. The structures placed in 1989 were tire structures, discarded conifer trees and/or hardwood brush, felled shoreline trees, stake trees, and modified cribs constructed from used picnic tables. All of these habitat structures, with the exception of the felled trees, were constructed from castoff materials.

This trend of using discarded materials for artificial habitat was noticed by the general public. In some cases, well-meaning citizens placed their soon-to-be-thrown-away materials (junk) in their favorite lakes, too. The belief was that, "if the Fish Commission can do it, so can I." This continued until some reservoir managers stopped habitat improvement projects altogether, due to an overabundance of "non-approved habitat structures" found in their dam gates. The trend was a difficult one to break, since part of the justification of using these types of materials was called "recycling." Furthermore, established wisdom said that employing anything but used materials as fish attractors was not cost effective. Discarded tires and leftover Christmas trees were not worth anything, but were expensive to dispose of, which further fueled the recycling benefit of artificial habitats.

Other problems surfaced regarding the use of recycled materials as fish habitat, in the form of outcries from anglers and the scientific community. Many in the scientific community claimed that tires, Christmas trees and other artificial structures made from recycled materials did not have a realistic habitat value, but were just devices to draw fish to the angler's hook, which could deplete fish stocks.

Submerged Christmas trees appeared to be great attractors of pre- and post-spawn panfish, in the first few years after they were sunk, but the trees lost their habitat value when most of the fine branches and needles disappeared. More and more biologists, anglers and reservoir managers in Pennsylvania made it known they were not happy with discarded/recycled materials being used for artificial habitats.

In 1988, the Fish & Boat Commission's Cooperative Habitat Improvement Program (Bureau of Fisheries, Division of Environmental Services) and the Adopt-a-Stream Program (Bureau of Education and Information) were combined. They became the Cooperative Adopt-a-Stream Program, managed by the Adopt-a-Stream Section within the Bureau of Property and Facilities Management, Division of Property Services.

The new program generated even more interest, by both volunteers and other state and federal agencies, in FHI in Pennsylvania impoundments. More funding to conduct FHI was becoming available through private and public sources. State-of-the-art artificial habitat structures were being manufactured, using plastics and other high-tech materials. Major U.S. companies were

marketing these devices as the answer to all the habitat problems associated with impoundments and reservoirs.

But as time went on, it became increasingly obvious that artificial habitat structure needed to be completely redesigned. After soliciting design criteria from a number of sources, determinations were made that the structure had to fulfill certain requirements:

- Useful as a deepwater (greater than 10 feet) juvenile structure
- Simple and easy to construct from new, biodegradable materials
- Have a relatively long lifespan when submerged
- Easily and safely transported by boat

Watercraft transport of artificial habitats was necessary, due to the limitations of building the structures on ice-covered or drawn-down impoundments. Because of the inconsistencies of ice-out, structures that had been placed at one site often did not end up submerged in the same place. And there were dangers associated with working on the ice. In some cases, the structures acted as solar collectors, thinning the ice around themselves and creating a hazard for anyone who approached. Also, once the structures were placed, they could be easily vandalized.

On April 25, 1990, with the assistance of the Allegheny Mountain Bass Anglers and Yellow Creek State Park, the first Pennsylvania Porcupine Crib was installed at Yellow Creek Lake, in Indiana County. This structure and this event brought about much-needed change in lake habitat methods and provided a means of setting new goals and objectives for the entire lake habitat improvement program.

Today the renamed Cooperative Fish Habitat Improvement Program is managed by

the Lake Section, within the Division of Habitat Management. The program was transferred from the Bureau of Property Services and Facilities Management back to the Division of Environmental Services in 1996, and then into the Division of Bureau of Fisheries Habitat Management in 2005.

The Pennsylvania Porcupine Crib was the first artificial habitat structure designed in the Commonwealth, using new, long-lasting biodegradable materials. It was also the first habitat device designed with fish protection—not fish attraction—as an objective. By 1993, the Porcupine Crib had replaced most other offshore, coarse brush structures (and tire structures) in 99 percent of the Fish & Boat Commission-approved habitat improvement projects in Pennsylvania impoundments. By the spring of 1995, more than 2,000 Pennsylvania Porcupine Cribs had been placed in Commonwealth reservoirs. Since then, other structures have been designed to meet other fishery needs, using the same materials and design criteria and with methods similar to the original Pennsylvania Porcupine Crib.



**One objective of habitat management is to create artificial habitats that fish (and turtles) use to accomplish survival tasks.**

*The Pennsylvania Porcupine Crib was the first artificial habitat structure designed in the Commonwealth, using new, long-lasting biodegradable materials.*

## GOALS AND OBJECTIVES

Historically, criticism of habitat improvement in impoundments came in many forms and from a variety of people. Sportsmen's groups complained that for all the effort and money they put into structure placement (brush, Christmas trees and tires), they saw few positive results. Christmas trees and brush structures did not last long enough to be effective, and tire structures were not very productive. Some fisheries managers said that all that artificial structure was good for was to attract fish to the angler's hook; it did not provide a realistic habitat value. Many impoundment managers were angered by discarded Christmas trees and tires floating in their reservoir, creating boating hazards and/or maintenance problems for dam tenders.

Anglers claimed that fish populations in many of the Commonwealth's impoundments were declining at an alarming rate. At the same time, fishing pressure was on the increase in Pennsylvania's lakes and reservoirs, and warmwater/coolwater angling was growing in popularity. Impoundment was also taking its toll on whatever native cover and substrate existed originally on the flooded landscape.



**Most Pennsylvania impoundments have very little cover for fish to use to accomplish survival tasks.**

By design, most of the reservoirs in Pennsylvania were constructed with little, if any, regard to fish or fish requirements or habitats. Prior to impoundment, the beds of the reservoirs were cleared of trees and brush. This created a barren and featureless environment for fish and anglers alike. Although the hope was that abundant and appropriate aquatic vegetation would establish itself, this has come true only in a small number of impoundments.

For the most part, aquatic vegetation in impoundments is either over-abundant or nonexistent. In reservoirs where aquatic vegetation does

exist, desirable species that provide good fish habitat are rare. Even when an impoundment contains appropriate submerged aquatic vegetation, the natural habitat it produces is seasonal, leaving both shallow and deepwater environments devoid of cover during much of the year.

Clearly, artificial habitats were needed to fill this deficiency in reservoir management. The habitat void was created when the impoundment was constructed. Since impoundments and reservoirs are designed, constructed and maintained by people, the only "natural" parts of their environment are the fish and the aquatic vegetation that propagate there.

Physical objects found in the impoundment are either "native" (there originally) or "artificial" (constructed) habitats. Since an impoundment requires management in many forms (aquatic vegetation, boating, angling, access, water levels, etc.), habitat management is a logical method to help achieve fishery production potential.

Fishery potential is directly related to the individual impoundment's production factors. These factors combine to provide the production and reproduction limits of all aquatic life within the impoundment. The fishery habitat requirements, one aspect of the production factors, are general types of habitats that all sportfish require to naturally propagate in the artificial environment of an impoundment or reservoir.

Enhancing these habitats where they exist, or providing them where they do not, is one goal of fish habitat management in Pennsylvania impoundments. The objective is to accomplish this

*Enhancing these habitats where they exist, or providing them where they do not, is one goal of fish habitat management in Pennsylvania impoundments.*

goal through the design, construction and placement of long-lasting, functional, artificial fish habitats, constructed primarily of natural materials, that meet the needs of the impoundment's habitat requirements and fit the impoundment's existing native habitats and classification.

The uniting of a particular artificial habitat structure to an existing "native habitat" should produce a fishery habitat within the impoundment that fulfills one or more of the fishery habitat requirements. The successful matching of an existing "native habitat" and the correct "artificial habitat" should then be limited only by the impoundment's other production factors.

The ultimate goal in any Pennsylvania Fish & Boat Commission habitat management project in a lake, pond or reservoir is: "To bring about positive change in the fishery through altering physical features of an individual impoundment to a point where 30 percent to 50 percent of the entire impoundment contains structure." Structure can be defined as any physical element—native, natural or artificial—that provides cover to aquatic animals.

### **U.S. ARMY CORPS OF ENGINEERS PERMIT REQUIREMENTS (Section 404)**

The U.S. Army Corps of Engineers, under Section 404 of the Clean Water Act, requires a permit to place any material (or structure or device) in any waterway (stream or impoundment) with a flow greater than five cubic feet per second. A general permit (SPGP-3) must be obtained for the construction, installation and maintenance of Pennsylvania Fish & Boat Commission-approved Fish Habitat Enhancement Structures in waters of the Commonwealth of Pennsylvania. SPGP-3 is automatically covered by the approval of the Pennsylvania general permit (BDWW-GP-1).

### **PENNSYLVANIA DEPARTMENT OF ENVIRONMENTAL PROTECTION (Chapter 105)**

Placing any device in the waters of the Commonwealth is regulated by the Dam Safety and Encroachment Act of 1978 (amended 1991), PL 1375, No. 325 as amended by Act 70. Under this act, fish habitat enhancement structures (artificial fish habitats) are considered an encroachment and/or water obstruction. To provide a simple method of permitting Pennsylvania Fish & Boat Commission habitat enhancement structures, the Department of Environmental Protection has issued a general permit (BDWW-GP-1) that is in alignment with the U.S. Army Corps of Engineers general permit (404). This general permit (105), when coupled the Corps permit, covers most typical habitat improvement project permitting needs. All fish habitat improvement plans using these general permits must be designed and/or approved by the Pennsylvania Fish & Boat Commission's Division of Environmental Services or Habitat Management Section.

### **PENNSYLVANIA FISH & BOAT COMMISSION LEGAL REQUIREMENTS**

The Fish and Boat Code regulates fish and boating activities in the Commonwealth. These regulations have a direct relationship to the management and protection of native, artificial and natural fish habitats. 1980 - 175, Title 30, Pennsylvania Consolidated Statutes pertains to fish habitats and habitat enhancement structures. These are for the protection of fish habitats, both natural and artificial.

#### **1. Chapter 25, Section 2502**

##### **Disturbance of waterways and watersheds**

- (a) No person shall alter or disturb any stream, stream bed, fish habitat, water or watershed in any manner that might cause damage to, or loss of, fish, without the necessary permits.
- (b) Penalty—Any person violating the provisions of this section commits a misdemeanor of the third degree.

*The ultimate goal in any Pennsylvania Fish & Boat Commission habitat management project in a lake, pond or reservoir is: "To bring about positive change in the fishery through altering physical features of an individual impoundment to a point where 30 percent to 50 percent of the entire impoundment contains structure."*



## 2. Chapter 35, Section 3506

- (a) Interference with dams or devices: Dams, deflectors, retards or similar devices placed across or in any waters inhabited by fish, with permission from the owners or owner of the land adjacent thereto or through which such waters flow, shall not be destroyed, removed, breached, or disturbed, except by written permission first obtained from the Commission.
- (c) Any person violating the provisions of this subsection commits a summary offense of the first degree.



***All fish structures placed in Pennsylvania waterways require state and federal permits and landowner permission.***

# SECTION 2

*... most of Pennsylvania's lakes are not lakes at all, but are manmade impoundments.*

## LAKES, PONDS AND RESERVOIRS

Pennsylvania's boundaries contain more than 3,956 lakes, ponds and reservoirs (<sup>1</sup> U.S. EPA, 1993). This does not include the Commonwealth's thousands of ponds, which represent another type of impoundment. Unlike other states, such as Minnesota, and Canadian provinces, like Ontario and Quebec, most of Pennsylvania's lakes are not lakes at all, but are manmade impoundments.

### RESERVOIRS

A dam built from earth, concrete, stone, wood or a combination of these materials impounds water to create a reservoir. The dam, or control structure, is constructed on a major waterway (stream or river), and the reservoir is contained by the dam within the boundaries of the dammed waterway's valley.

Impoundments differ from natural lakes in many ways, but the greatest difference may be in the way they age. Impoundments age quite rapidly, while natural lakes undergo succession much more slowly. When a reservoir is in the early to middle stages of its aging transformation from an impoundment to a wetland, it may be reclaimed simply by drawing the water level down and removing the sediment. Reclaiming a natural lake is not that simple. Indeed, engineering-wise, natural lake reclamation may be nearly impossible, once the lake has completed its succession to a wetland.

Impoundment reclamation (both reservoirs and ponds) is expensive. In most cases, reclamation requires dredging and hauling away hundreds or even thousands of tons of sediment. Depending on the stability of the watershed that feeds the impoundment, reclamation may be needed again in a couple of decades. When making comparisons between natural lakes and impoundments, it is important to remember that a reservoir may be considered an artificial lake, created by man for recreation, flood control or to reserve water for human or livestock consumption, or any combination of these justifications. In this text, we will refer to artificial lakes as impoundments, reservoirs or ponds, and we will refer to natural lakes as lakes.

### PONDS

Although ponds may be considered a type of impoundment, major differences exist between ponds and reservoirs. The main differences are in the control structure and the size of the waterway that feeds the impoundment.

In general, ponds are small impoundments that are contained within a completely artificial boundary, rather than a valley. Most ponds are not created by impounding a major waterway. Instead, most Pennsylvania ponds are fed by springs and/or very small perennial or intermittent streams (normally a diversion). The dam breast is generally constructed of earthen fill and surrounds much of the impoundment. Most ponds in Pennsylvania are rather featureless and bowl-shaped, while most reservoirs are created with the natural landscape determining their boundaries.

Another major difference between ponds and reservoirs is overall size. Most ponds are two to



*Most Pennsylvania lakes are manmade impoundments, rather than natural lakes.*

<sup>1</sup> U.S. EPA (1993) *Total Water Estimates for United States Streams and Lakes*

10 surface acres, with maximum depth at the center being 10 feet. Since most ponds are small and featureless, they normally cannot sustain a large or diverse fishery. In many cases, ponds that are fed only by springs have a coldwater/coolwater foundation, depending on the season of the year, current weather conditions and inflow volume. Ponds that are supplied by diverted small streams are normally very fertile and have a rich aquatic ecosystem.



*Pennsylvania has very few natural lakes.*

### NATURAL LAKES

Unlike manmade impoundments (reservoirs and ponds), natural lakes are natural creations. Only a handful of natural lakes exist in Pennsylvania, and most of these are quite small. All of the natural lakes in the state are found north of I-80, in the northeastern and northwestern regions of the Commonwealth, and are the result of glaciation.

Pennsylvania's natural lakes are geologically old and are considered "middle-aged in relationship to earth's history." The successional

changes in a natural lake, which we call "aging," are based on the evolution of conditions, rather than on the lake's years of existence. This means that the total environment of the lake—its structural condition, food chains, vegetation species, fish abundance and dominant fish species—changes through time. These environmental conditions are impacted greatly by man's interference with natural processes.

Most of the natural lakes in Pennsylvania began as infertile, coldwater environments, have evolved through the coolwater phase and are now in the process of transition to warmwater environments. Even with all their modern technology, people cannot stop the aging process of natural lakes.

### IMPOUNDMENT AGING

The day an impoundment begins to fill with water is the day the aging process of that impoundment begins. Impoundments age at a much greater rate than a natural lake. The fishery within the new impoundment normally reaches its production peak in the first seven years of the impoundment's existence. Fishery production levels out or slowly declines after the reservoir has reached this point in its aging process.

Once the fishery in an impoundment has reached maximum potential, it remains somewhat stable for the next decade. The impoundment's ability to continue to produce fisheries at this level depends on the impoundment's environmental stability. The impoundment's health and longevity directly relate to surrounding and upstream land uses, local weather conditions and the recreational use and management of the impoundment. Although weather and recreational use indirectly play a part in the aging process of an impoundment, surrounding land conditions and watershed drainage have the biggest effect on the health of the impoundment.

### ENVIRONMENTAL CHARACTERISTICS OF IMPOUNDMENTS AND LAKES

Lakes and impoundments have certain universal characteristics. One of these is the seasonal shifts of water temperature and density zones that occur in most lakes and impoundments in Pennsylvania. These seasonal shifts (water zones), known as thermal stratification, develop as sunlight penetrates the water to varying degrees, producing layers of varying temperatures.

Typical summer stratification starts at the surface, with the epilimnion (a lightweight, warm layer of water). Below that is the thermocline, the zone where drastic water temperature decline occurs. The layer from the thermocline to the bottom is the hypolimnion, the coolest portion

*Impoundments age at a much greater rate than a natural lake.*

*... a particular fish community (coldwater, coolwater or warmwater) is restricted to certain layers of the water at various times of the year, due to that fish community's water temperature and dissolved oxygen needs.*

of the lake or impoundment's aquatic environment. The hypolimnion is often devoid of dissolved oxygen.

Autumn brings cooler air temperatures and a new seasonal shift, as the epilimnion cools and sinks. This, in turn, drives nutrient-rich water from the depths, upward. Once ice forms on the surface, water temperatures reverse. During winter, the coldest temperatures in the lake or impoundment are found closest to the surface, while the warmest water is contained near the bottom. In spring, the process reverses again. The lake or impoundment "flips," and the shift is toward summer stratification.

In the aquatic environment, fisheries are bounded by the preferred water temperature of the fish species or fish community. This means that a particular fish community (coldwater, coolwater or warmwater) is restricted to certain layers of the water at various times of the year, due to that fish community's water temperature and dissolved oxygen needs.

## IMPOUNDMENT PRODUCTION FACTORS

Fishery production factors for impoundments relate to the individual elements that make up an impounded aquatic environment. Each element is individually important, and, in combination, the elements comprise the aquatic environment within an impoundment.

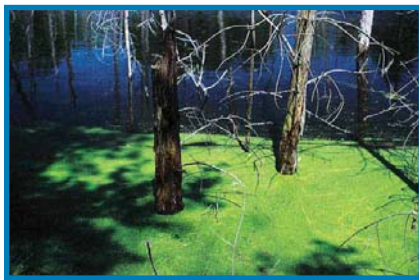

**Water quality is the most important production factor and sets limits for all other factors.**



**The stability of the watershed has a big influence on the aging process of the downstream impoundment.**

- 1. Water Quality:** Water quality is the first and foremost production factor. The water quality of the impoundment sets the stage for the overall health and longevity of the impoundment.
- 2. Watershed Stability:** The health and stability of the watershed that feeds the impoundment determines the water quality (minerals and metals) and sedimentation (silt and organic) standards for the reservoir. In turn, water quality and sedimentation influence aquatic vegetation production and fisheries.

**3. Impoundment age:** The aging process of the impoundment relates to land uses both in the watershed and around the impoundment. In simplistic terms, as an impoundment ages, it gradually fills with sediment and nutrients (silt and organic material). Reacting to sediment and nutrient loading within the impoundment, the epilimnion shrinks, reducing the aquatic environment available to the fish community. The rate of aging relates to the watershed's health and stability, which affect the delivery rate of nutrients and sediment. The healthier and more stable its watershed, the slower an impoundment ages.

- 4. Substrate Diversity:** The quality and quantity of an impoundment's native and natural habitats are a direct result of the substrate types found in the impoundment. Along with water quality, this determines the impoundment's ability to produce aquatic vegetation and set the stage for fish spawning and aquatic insect abundance and diversity.
- 5. Natural Habitats (Submerged Aquatic Vegetation):** Submerged aquatic vegetation abundance and variety are a result of an impoundment's water quality, substrate diversity and material, and nutrient wealth. They are also determined by the rate of water exchange within the impoundment. Rapid flow-through can have a "flushing effect" on material and



*The occurrence and abundance of aquatic vegetation play an important fish habitat role in any impoundment.*

on nutrient loading. Along with the impoundment's water quality and substrate, its watershed (the waterway and land area that feed nutrients to the lake), plus other associated local factors, determine aquatic vegetation species and abundance. Depending on the species and quantity, aquatic vegetation may provide excellent habitat for an array of aquatic animals.

**6. Native and Artificial Habitats:** The diversity and abundance of both native and artificial fish habitats play an important role in an impoundment's ability to produce fish. Fish utilize habitats to accomplish daily and seasonal tasks (spawning, foraging, resting, protection, etc.). When adequate

and appropriate fish habitats are available, fish can accomplish these tasks with great efficiency. Some fish species cannot naturally propagate, unless appropriate habitats exist. When appropriate native and artificial habitats do exist, habitat abundance may be the limiting factor in determining a fishery's success on an impoundment-wide basis. Native habitat types include benches, breaks, boulders, channels, flats, reefs, shoals and wood (stumps, trees, etc.)

**7. Impoundment Characteristics (Classification):** An impoundment's physical characteristics play a large part in its ability to produce fish and help to determine what fish species will naturally propagate within the confines of the impoundment. Physical characteristics are also a factor in determining the impoundment's artificial habitat requirements. This determination is accomplished through a classification system (See Habitat Classification for Pennsylvania Impoundments, page 39). The classification system organizes a combination of typical characteristics (the impoundment's bays, coves, points and dam breast) and particular native habitats that are normally found in that type of impoundment.



*The impoundment's native characteristics lay the groundwork for other production factors.*

**8. Water Level Stability:** A stable environment for fish provides the best opportunity for effective propagation. When water levels fluctuate in impoundments, the result can be loss of aquatic habitats. This loss comes from freezing out submerged aquatic plants and destroying woody habitats (both native and artificial). Native habitats, such as stumps and woody debris, can dry and float when the impoundment is refilled. Artificial habitats can be vandalized or destroyed by ice or wave and wind action. Drawdowns can have negative effects on fisheries, too. Not only is there a loss of habitat due to the drawdown, but also the remaining, small pool area concentrates forage fish populations, allowing predators to be more effective.

**9. Fisheries Management Strategy:** Determining species selection and regulation restrictions plays a major role in the overall production of fish stocks in an individual impoundment. In conjunction with creel and catch limits designed to best manage the fishery within that individual ecosystem, the fish species' relationships to each other, plus their relationship to the other factors, determine or limit fisheries production.

**10. Recreational Use:** The types and frequency of recreational activities that occur on an

*The diversity and abundance of both native and artificial fish habitats play an important role in an impoundment's ability to produce fish.*

*Adult fish must successfully spawn, if natural propagation of the species is to occur.*

impoundment have a direct relationship to its fisheries management strategy. Fisheries managers determine size and creel regulations that limit angler harvest. Recreational use can affect fishery production by way of angler activity and harvest. Heavy angling pressure and a high rate of angling success can have an impact on the overall fishery production of an individual sportfish or forage-related species.

## IMPOUNDMENT FISHERIES HABITAT REQUIREMENTS

Most fish living in an impoundment or lake have similar fishery habitat requirements.

Depending on species and impoundment type, most gamefish and panfish require certain physical elements to be present, in order to accomplish daily and seasonal survival tasks (as individuals or species). To naturally propagate, fish must accomplish all of these required tasks using various habitat types existing in the lake or impoundment. In theory, the more effective the impoundment's habitats, the more efficient the fishery can be at accomplishing necessary habitat-related tasks.

- 1. Spawning:** Adult fish must successfully spawn, if natural propagation of the species is to occur. Appropriate and abundant spawning habitats for individual species must be present for spawning to be successful.
- 2. Nesting:** Many fish species nest as part of their spawning requirements. Nesting requires appropriate substrate and, in many cases, overhead cover. The better the substrate is for nesting, the more successful a fish species can be at natural reproduction and propagation.
- 3. Nursery:** After spawning occurs, young-of-the-year (YOY) of different species require a variety of specific habitats to successfully survive and recruit from juvenile to adult life stages. When necessary nursery habitats are nonexistent or not sufficiently abundant, YOY recruitment to juvenile stage can be limited by increased predator success.
- 4. Refuge:** Refuge habitat primarily applies to juveniles that have recruited from YOYs (second-year fish). As with YOY survival, juvenile survival can be greatly enhanced, if appropriate and abundant habitats exist for that particular species or year-class.
- 5. Foraging:** Foraging habitats enable predators to feed on native forage (not necessarily associated with overhead cover). The same habitat used by predators to forage may be necessary for the native forage to naturally propagate. For instance, burrowing mayflies may utilize a particular substrate until emergence. The same substrate or habitat may be used by walleye (or another species) to forage on the mayflies after emergence.
- 6. Ambush:** Some fish species require concealment cover to effectively ambush their natural prey. Both adults and juveniles of a variety of species may use ambush cover when foraging. Where appropriate and abundant ambush habitats exist, fish such as largemouth bass (and other species) can be more efficient at foraging for native prey species.



*Sonar shows gamefish using artificial habitat structures to forage on baitfish. Gamefish may use artificial habitats to ambush prey, rest, spawn and nest, and for refuge and nursery cover.*

- 7. Resting:** Although this requirement is not always recognized, fish do need to rest. Resting often comes in the form of not foraging, migrating, spawning or accomplishing other necessary survival tasks. In many cases, fish rest in or around habitats that are not used for any task but resting. Adult walleye will rest on the bottom of a deep-water flat. Smallmouth bass

may select deep-water cover along a steep, vertical shoreline. Largemouth bass may seclude themselves among the roots of a stream-channel stump. If fish are to survive, they must “turn off the switch” now and then. This is what many anglers call “negative fish”—fish that are not feeding, but resting.

- 8. Migration:** All fish travel and most fish migrate. Many fish migrations occur because of spawning or foraging needs. Fish migrations do not need a specific habitat type, although fish do utilize habitats when they migrate. Bass, in particular, may use habitats to navigate, employing specific habitat features as landmarks to map travel routes.

*All fish travel  
and most fish  
migrate.*

## NATIVE HABITATS

When an impoundment is constructed and a fishery is created, various features within the water body become fisheries habitats. The features or habitats that existed at the time of reservoir flooding are considered to be native fish habitats. Native habitats are impoundment features fish use to accomplish one or more of the species' or the individual fish's daily or seasonal survival tasks, which are associated with the impoundment's production factors. In some cases, these native habitats are considered structure, since some of the most productive native habitats are irregular and abrupt underwater physical features.

Fish & Boat Commission Habitat Management staff use specific native habitat types, along with the impoundment classification system, to determine what and where artificial habitats would be the most beneficial. The quality, profusion and variety of native habitats existing in the impoundment provide a basis for potential fishery production, through spawning, nesting, refuge, foraging and forage habitats. The combined diversity, abundance and specific native habitat types found in a particular impoundment ultimately determine the impoundment's classification.



*Native fish habitat exposed during a seasonal drawdown.*

Typical native habitats found in Pennsylvania impoundments are stream and river channels; shoreline slopes, breaks, benches and flats; woody debris, stumps and root wads; shoals; reefs; boulders; roadbeds; bridges; and dwellings.

## NATURAL HABITATS (Aquatic Vegetation)

Natural habitats (aquatic vegetation) occur when substrate and water quality and quantity conditions correspond with particular aquatic vegetation species' growth requirements. Aquatic vegetation is considered to be a natural habitat, because aquatic vegetation growth occurs in a manmade impoundment by natural means. Aquatic vegetation may be transported by waterfowl migration or through natural drift from feeder streams in the watershed.

Even though aquatic vegetation is not currently managed as a fish habitat, vegetation control is being conducted on numerous state-owned impoundments. The objective of much of the aquatic vegetation management in Pennsylvania's state-owned impoundments is to open areas to recreational boating and swimming. Removing small amounts of submerged aquatic vegetation in zones of heavily concentrated recreation can actually improve fish habitat. The openings or lanes create a greater edge effect, an important factor in the effectiveness of any fish habitat.

Aquatic vegetation can play a major role in fisheries production as a fish habitat, but this is dependent on the species and abundance of both the fish and the vegetation. Some species of submerged aquatic vegetation may provide excellent juvenile or young-of-the-year survival habitat, while other vegetation species may enhance foraging opportunities for adult fish or spawning habitats.

## ARTIFICIAL HABITATS

Artificial habitats (refuge, spawning, nesting, ambush, foraging, migration, resting and nursery) are designed to be effective, long-lasting structures, providing habitats that allow fish to accomplish their daily and seasonal tasks with greater efficiency.

Some artificial habitats serve several purposes. They may provide increased opportunities for anglers to catch and/or harvest fish (fish attraction). They may provide increased surface areas

*Aquatic vegetation can play a major role in fisheries production as a fish habitat ...*





**Artificial fish habitats constructed during a drawdown period to rebuild a dam.**

for algae attachment, aquatic insect colonization and for other food organisms, which may increase fishery production. Many artificial habitats are designed to allow fish species to accomplish daily and seasonal survival tasks (performance structures), which may also provide an opportunity to increase productivity within some impoundments.

Small fish may use habitat (artificial, native or natural) to avoid predation, occupying niches where predators cannot forage. In turn, predator fish may utilize complex habitat as foraging areas. Increasing complex habitat may allow

the coexistence of predators and prey, through the creation of more microhabitat types. Adding habitat complexity may positively influence predator efficiency, by providing small fish with refuge in areas of high structure densities.

Complex structural cover may also provide important habitat for aquatic invertebrates, offering foraging opportunities for juvenile and adult panfish that rely on invertebrates as a food source. Complex structure may also serve as habitat for prey resources of black bass and other predators, increasing prey/predator efficiency.

Simple structural cover (bass nesting structures, half-log structures) can be more effective at providing positive spawning, nesting and parental habitat for black bass, than complex cover. One reason may be that simple cover has less microhabitat types for invertebrates and refuge areas for small fish. Some studies show that angler success does not increase during spawning/nesting periods in spawning areas that have been treated with simple artificial cover. Simple structural cover can play a major role in black bass spawning and nesting success, when placed at appropriate sites, with suitable substrate.

Some artificial habitat structure designs matched with appropriate native habitats (physical features existing in the impoundment) may be species-selective or show a preference toward individual size (juvenile vs. adult) and/or fish habits. Artificial habitats known as “forage-type structures” are designed to provide basic habitat needs of the impoundment’s forage base (bait-fish, invertebrates and crustaceans). Often, numerous artificial habitat types are required in an impoundment to provide habitat diversity (complex and simple; wood and rock; shallow and deep). This creates an opportunity for a more diverse fish community to develop and flourish.

Large, complex wood structure in lakes may create positive fish habitat for a variety of species. Due to its excellent submerged capabilities, rough-cut hemlock lumber is used in all the wood structure designs for complex artificial fish habitat. In some instances, large hardwood trees are used to make sizeable woody structure. Other materials used in construction of artificial fish habitats include sandstone, limestone rock, concrete blocks, nails and nylon banding.

All artificial habitats used in this plan have undergone a minimum one-year design phase and two-year durability test. Materials and construction techniques used in the assembly of Pennsylvania artificial habitat structures provide the best balance of structure longevity, invertebrate and plankton colonization and fish utilization. Lumber used in the construction of Pennsylvania artificial habitat structures must be green (newly cut), rough-cut, true-dimensional hemlock or yellow poplar. If other lumber types are required, they will be specified in the plans. All other material types used will be noted in the plan, as a specific type of material required for that particular structure.

*Large, complex wood structure in lakes may create positive fish habitat for a variety of species.*

*Porcupine Cribs are long-lasting, deep-water, complex structures designed as a refuge-type habitat.*

### **PENNSYLVANIA PORCUPINE CRIB**

Porcupine Cribs (see standard drawings) are long-lasting, deep-water, complex structures designed as a refuge-type habitat. This design should provide protection for juvenile fish and improve recruitment of panfish and gamefish in impoundments that lack abundant, deep-water, submerged aquatic vegetation. Construction materials consist of rough-cut, true-dimensional, green (fresh cut) hemlock or poplar (50 pieces of 2" x 2" x 4'), eight two-core 8-inch concrete blocks (minimum 35 pounds each) and two pounds of 16d common bright nails (two strips of 12d strip nails for nail guns), plus a 14-foot piece of ½" nylon security banding and one steel buckle.



*Pennsylvania porcupine crib*

Placement is traditionally accomplished by specially-equipped watercraft, during soft-water periods (no ice). These structures may also be constructed on-site, during drawdown periods. Submerged structures are normally placed in a row or alternating row pattern, with four to eight-foot spaces between individual structures. Normally, 10 to 20 Porcupine Cribs are placed at one site. Structures are submerged in 10 to 15-foot depths along the bottom contour, parallel to the shore. Typical placement density is 20 structures per acre.

Typically, native habitats in hill-land impoundments (see page 39) benefit most from coarse brush structures. High-gradient slopes, leading into breaks and/or channels, characterize these areas. Steep shores that break onto flats or benches appear to be effective native habitats, when treated with coarse-brush-type artificial structures.

### **PENNSYLVANIA PORCUPINE CRIB JR.**

The Porcupine Crib Jr. (see standard drawings) is an adaptation of the original Porcupine Crib, which was designed as a deep-water structure. The "Jr." is a shallow-water version, with additional density in the gable ends. The Porcupine Crib Jr. was first designed to mimic the habitat provided by native stumps. Stumps in shallow water provide an important habitat value in Pennsylvania reservoirs and are sometimes the only true woody cover in an impoundment.

As impoundments age, native stump fields may disappear, due to erosion by wind or by annual or seasonal maintenance drawdowns. As the stump fields disappear, so does that type of cover. Some impoundments do not contain any native stumps, as a result of policies in place during impoundment construction. Porcupine Crib Jrs. can provide alternative cover for pre- and post-spawning adult panfish and black bass, plus seasonal ambush and refuge cover for juveniles.

Construction materials consist of rough-cut, true-dimensional, green (fresh cut) hemlock or yellow poplar (38 pieces of 2" x 2" x 4'), eight two-core eight-inch concrete blocks, and two pounds of 16d common bright nails (two strips of 12d strip nails for nail guns), plus a 10-foot piece of ½-inch nylon security banding and one steel buckle.



*Pennsylvania porcupine crib junior*

Specially-equipped boats traditionally accomplish placement during soft-water periods (no ice). These structures may also be constructed on-site during drawdown periods. Normally 10 to 20 Porcupine Crib Jrs. are placed at one site. The Porcupine Crib Jr. is generally placed in a random fashion on shallow-water flats, in depths between six and 10 feet (unlike full-sized Porcupine Cribs, which are placed in rows near deep-water breaks), with varied distances between each individual structure. The “Jr.” is only 28 inches high, so even in six-foot depths, the structures are not a navigation hazard. The exception would be during drawdown periods, when the structure could become exposed. Typical placement density is 30 structures per acre.

### PENNSYLVANIA SHORT VERTICAL PLANK STRUCTURE



*Pennsylvania short vertical plank structure*

The Short Vertical Plank Structure is a shallow-water adult black bass habitat. “Shorties” are designed for shallow-water flats or slow-tapered shores, with depths ranging from five to 10 feet. The most effective flats or shores lead into stream or river channels. “Shorties” should be placed on flats in areas devoid of submerged aquatic vegetation. “Shorties,” with brush or conifers added to the interior, are a complex habitat that creates overhead cover for ambush, hunt and flush foraging by black bass, as well as refuge habitat for panfish. “Shorties” also provide excellent early season adult panfish cover, when coarse brush is added to the structure.

Vertical wooded and coarse brush structures have been found to be effective in shallow water (less than 10 feet) in hill-land and highland impoundments. The most effective placement appears to be in dense circles of structures, with one or more openings in the center, or irregular lines of structures, with large openings between individual devices (see standard placement drawing). Largemouth bass, sunfish, crappie and yellow perch favor coarse brush and wooden structures, when placed on or near steep gradient shores that break onto flats or benches.

Construction materials consist of rough-cut, true-dimensional, green (fresh cut) hemlock or poplar (32 pieces of 1” x 4” x 24”, 10 pieces of 1” x 4” x 48” and 35 pieces of 2” x 2” x 48”), nine two-core eight-inch concrete blocks (minimum 36 pounds each) and ½ pound of 16d common bright nails (approximately one strip of 12d strip nails for nail guns) and two pounds of 8d common bright nails (approximately two strips of 2<sup>5</sup>/<sub>8</sub>-inch strip nails for nail guns), plus a 10-foot piece of ½-inch nylon security banding and one steel buckle (see standard drawing).

The Short Vertical Plank Structure is 29 inches high, so it can be placed in depths between five and 10 feet and still be safe from boating traffic. The structures may create a navigation hazard during drawdown periods, where they become exposed. Typical placement density is 30 structures per acre.

### PENNSYLVANIA POST CLUSTER STRUCTURE

Most Pennsylvania-style artificial wood habitat structures are designed on a horizontal cover principle. Post Clusters are designed to create long-lasting, functional, vertical, shallow-water cover for game and panfish. Designed primarily for flatland and hill-land impoundments, Post Clusters utilize common agricultural fence posts, driven into the impoundment’s substrate in a cluster pattern, to create shallow-water, vertical ambush cover for black bass. Post Clusters also create simple microhabitat for aquatic invertebrates. These microhabitats may also serve as habitat for prey resources of black bass (and other predators), increasing prey/predator efficiency. Simple vertical habitat also provides camouflage-related benefits to game and panfish.

*Most Pennsylvania-style artificial wood habitat structures are designed on a horizontal cover principle.*

Pennsylvania Post Clusters are typically placed in three to four-foot depths, at slight angles to the water surface. Placement is accomplished during seasonal or maintenance drawdown periods, by specialized construction or agricultural-type equipment, with a hydraulic fence post driver. Typically, 8' x 6" posts are driven into the substrate, approximately three to three-and-a-half feet, allowing 12 to 18 inches of the post to be above the water surface in three to four-foot depths. Post Clusters are placed six to eight feet apart, with 25 posts to a cluster. Typical placement density is four (25-post) clusters per acre.



*Pennsylvania post cluster construction*



*Felled shoreline trees*

### FELLED SHORELINE TREES

Where sufficient depths exist near shore (greater than 15 feet), felling and cabling shoreline trees provides excellent fish habitat. Game and panfish use submerged trees in a variety of ways. Spawning, recruitment, foraging and refuge tasks are accomplished by many species and age-classes using felled trees.

Large, spreading hardwood trees are particularly suitable, because their complex branching systems create more complex habitat. Trees are felled and cabled to their stumps (see standard drawing), with ¼-inch galvanized wire rope and cable clamps. Typical placement density is five trees per acre.

### PENNSYLVANIA BLACK BASS NESTING STRUCTURE

Black Bass Nesting Structures are a spawning/nesting/nursery-type habitat, designed to accommodate the spawning/nesting/nursery habits of black bass (largemouth and smallmouth). Bass Nesting Structures are designed to provide maximum shallow-water (less than 10 feet) cover to adult bass, during the pre- and post-spawn periods, and dense refuge cover for young-of-the-year smallmouth and largemouth bass.

Classic native spawning habitats for black bass occur along south-facing shores in bays and inlets, but spawning may occur at main lakeshores, too. Native spawning sites treated with overhead cover appear to enhance adult spawning and nesting activities, plus improve young-of-the-year survival.

Construction materials consist of rough-cut, true-dimensional, green (fresh cut) hemlock or poplar (20 pieces of 2" x 2" x 4' and five pieces of 1" x 8" x 8'), eight two-core eight-inch concrete blocks (minimum 35 pounds each) and two



*Pennsylvania black bass nesting structure*

*Large, spreading hardwood trees are particularly suitable, because their complex branching systems create better fish habitat.*

pounds of 16d common bright nails (two strips of 12d strip nails for nail guns), plus a 10-foot piece of ½-inch nylon security banding and one steel buckle.

Specially-equipped boats traditionally accomplish placement during soft-water periods (no ice). These structures may also be constructed on-site, during drawdown periods. Normally, five to 10 nesting structures are placed at one site. Bass Nesting Structures are usually placed in alternating rows, in depths between five and 10 feet, depending on water clarity and the target species. The Bass Nesting Structure is only 15 inches high, so even at five-foot depths, it is not a navigation hazard. The exception would be during drawdown periods, when the structure could become exposed. Typical placement density is 10 structures per acre.

### **PENNSYLVANIA CHANNEL CATFISH SPAWNING BOX**



*Pennsylvania channel catfish spawning box*

These devices (see standard drawing) are a tool for propagating white catfish and channel catfish in impoundments, with the aid of annual plantings of juveniles. For successful natural reproduction to occur, adults require a hollow object to enter for spawning, which will provide nursery protection to young-of-the-year. These objects must have dark interiors and/or be well shaded and have only one entrance. Natural spawning habitats come in many forms, such as hollow logs, bank beaver or muskrat holes and rock crevices. Due to reservoir clearing during construction, little suitable native spawning habitat occurs in most Pennsylvania impoundments.

The artificial channel catfish spawning habitat is fabricated from 20 linear feet of 1" x 8" rough-cut hemlock lumber, 32 three-inch screws, and two 2" x 16" x 16" concrete patio blocks. The complete device is placed by submerging it from a watercraft, during soft-water periods (no ice). In impoundments where drawdowns occur, the device should be placed in an excavated trench and covered with substrate (see standard drawing). This provides a more natural appearance and makes it more secure from disturbance by wind and wave action and human interference.

Traditional placement sites are in shallow (three to five feet), silt-free areas of the impoundment, which provide warm water temperatures in late spring (75 degrees). Typical placement density is five structures per acre.

### **ROCK RUBBLE HUMPS/REEFS**

Rock Rubble Humps (see standard drawings) provide forage-type habitats for a variety of aquatic insects, crustaceans and baitfish. Rubble humps may also act as fish attractors for walleye, black bass and panfish, due to natural colonization by various types of aquatic insects. Fish use depends on location, hump or reef size and stone size diversity.

Traditionally, rubble humps are placed on flats or shoals in flatland or hill-land impoundments. The best method for placement is during maintenance or annual drawdowns, with heavy machinery. The Fish &



*Rock rubble humps*

*Due to reservoir clearing during construction, little suitable native spawning habitat occurs in most Pennsylvania impoundments.*

*Without appropriate basking habitat, many turtle species are not able to properly adjust body temperature.*

Boat Commission's Habitat Management Section, in cooperation with the Pennsylvania Department of Conservation and Natural Resources (DCNR) Bureau of State Parks and the Pennsylvania B.A.S.S. Federation, has designed and built a watercraft capable of placing rubble humps or spawning substrate during soft-water periods (no ice).

Suitable rubble includes sandstone or limestone, in sizes from fines to riprap. Broken concrete blocks are also utilized as rubble material. Rubble humps are defined as rock or concrete piles between one and three cubic yards (less than 2.5 tons). Rubble reefs are defined as rock or concrete piles between three and 10 cubic yards (2.5 to 7.5 tons). Typical placement density is 20 two-ton humps (40 tons) per acre.

### **PENNSYLVANIA TURTLE BASKING HABITAT PLATFORM**

Since the Pennsylvania Fish & Boat Commission is responsible for the protection and management of turtles in the Commonwealth, the Habitat Management Section has designed an artificial turtle basking habitat, in cooperation with the Fish & Boat Commission's Non-Game & Endangered Species Unit and DCNR's Bureau of State Parks, Codorus State Park.

Pennsylvania Turtle Basking Habitat Platforms were originally designed for red-bellied turtles at Lake Marburg, York County, due to a sighting of these rare animals. During the initial evaluation of the basking habitat structures at Lake Marburg, it was realized that the platforms were utilized by a variety of turtles, not just the Pennsylvania-threatened red-bellied. Other turtle species could benefit from the placement of artificial basking habitats.

Many Pennsylvania reservoirs contain little, if any, woody debris appropriate for turtles to use as basking habitat. This is primarily due to pre-impoundment reservoir clearing and continued debris removal. Without appropriate basking habitat, many turtle species are not able to properly adjust body temperature. Basking provides opportunities for resting and allows turtles to increase their body temperature, which promotes individual growth, aids digestion, reduces susceptibility to disease and improves overall health.

The sites selected for basking platforms are normally places where turtles have already been seen and where the structure will receive little attention from humans, during soft-water periods. These sites are generally in bays and coves in the upstream areas of impoundments. The Pennsylvania Turtle Basking Platform is a modified version of the original Codorus design. The modification makes the platform less complicated to construct and provides increased escape possibilities. The structures are made of rough-cut, true-dimensional hemlock or yellow poplar (see attached standard drawing). Specially-equipped boats accomplish placement during soft-water periods (no ice). The basking habitats are anchored in place by two 8" x 8" x 16" concrete blocks and ¼-inch stainless steel wire rope. Typical placement density is five structures per acre.

### **BRUSH (CHRISTMAS TREE) STRUCTURES**

Although the Fish & Boat Commission does not currently use discarded conifers to build and place Christmas tree structures, there is documented success of these structures' providing spawning habitat and cover for a variety of fish in some Pennsylvania impoundments.



*Pennsylvania turtle basking habitat platform*

## STRUCTURE CONSTRUCTION AND PLACEMENT ACTIVITIES

The construction and placement of all artificial structures discussed in this publication must be coordinated with the Fish & Boat Commission's Lake Section of the Division of Habitat Management. Staff from the Lake Section (or a designated representative) will be on hand to supervise and assist in construction of all artificial habitats designed for approved and active Cooperative Habitat Improvement Projects in impoundments owned and controlled by the Commonwealth of Pennsylvania. Specialized Fish & Boat Commission tools and equipment may also be utilized by the cooperator to construct artificial structures, supervised by Habitat Management staff. In most cases, placement of artificial habitats can be accomplished by specially-equipped Fish & Boat Commission watercraft, operated by trained Lake Unit staff. Other state and/or federal watercraft and operators may also be used to accomplish projects managed by the Division of Habitat Management.



Loading a Porcupine Crib Jr. on the "structure boat," preparing to haul and submerge it.

## IMPOUNDMENT HABITAT MANAGEMENT METHODS

Twenty years of work with artificial fish habitats, in warmwater impoundments, have shown that a functional, artificial habitat structure can be designed for a specific habitat requirement for a particular fish species. The design can be successful in providing an opportunity for individuals of that species to accomplish the survival task for which the structure was designed. Experience has also shown that other fish species may utilize the same artificial habitat at a different time or place and for a completely different reason. Fish adapt, using provided habitats to survive and becoming more effective and efficient in accomplishing their necessary survival tasks.

In designing effective artificial habitats, the key is to determine what the fish's (panfish, gamefish, baitfish, aquatic insects, crustaceans, etc.) habitat needs are to offer that type of artificial habitat in the correct location and on the appropriate native habitat type, within the particular impoundment. Then engineer and construct these artificial habitats to be structurally sound and provide long-lasting service, with a low digression rate.

Typical Pennsylvania habitat enhancement projects begin with research into fish management data, which provides basic information on the condition of the fisheries in the impoundment or lake. Discussions with the Fish & Boat Commission area fisheries manager help to determine specific fishery and habitat needs. Local angler input about habitat needs is also critical in determining habitat preferences and appropriate locations for artificial habitats. Angler knowledge is valuable in the assessment process, helping to locate native, natural and artificial habitats that already exist in the impoundment.

Projects are designed utilizing the impoundment's existing native and natural habitat features. An inventory of these habitat features is used as a foundation for artificial habitat placement, through a "habitat classification system" (Habitat Classification for Pennsylvania Impoundments). The classification of an individual impoundment provides the Lake Habitat Manager with a basis for artificial habitat locations, through categorizing typical physical aspects (native habitats) of impoundments and comparing those with other impoundments that have similar features.

This classification or determination of physical features is important because fish species tend to use different native habitat types in a flat-land impoundment than they do in a highland impoundment, when accomplishing the same task. Impoundments that are classified the same (similar physical characteristics) and that have similar water quality, fish stocks and substrate will have fish species utilizing the same native habitat types to accomplish the same basic tasks.

Pennsylvania artificial habitats were developed with fishery requirements as the first design priority and existing native habitat features as the second priority. When a particular native habitat type found in a hill-land impoundment is treated with a specific type of artificial habitat that functions correctly, it can be assumed that if this is duplicated in another hill-land impoundment, with similar water quality and fish stocks, the results will be similar.



*Unique equipment and methods are used to create diverse and functional artificial habitats in Pennsylvania's lakes and impoundments.*

*Fifteen years of work with artificial fish habitats, in warmwater impoundments, have shown that a functional, artificial habitat structure can be designed for a specific habitat requirement for a particular fish species.*



## POND HABITAT MANAGEMENT METHODS

Although no pond classification system, per se, is in place, the term “pond” has already classified the impoundment. Because most ponds are constructed in a similar fashion, comparisons can be made relating to fish habitats. Since almost all ponds are bowl-shaped, they tend to be featureless, with little structure or physical irregularities.

Most aged ponds tend to contain an abundance of shallow-water, submerged aquatic vegetation and a limited amount of emergent aquatic vegetation. Depending on its density, diversity and species, the aquatic vegetation alone may provide at least part of the necessary habitat for fishery success.

Pond habitat management can utilize the same principles as reservoir management. Matching structures to fishery requirements and existing depths and contours of the pond will help determine habitat needs. If a typical pond contains a warmwater (bass, bluegill, bullhead, fathead minnow) fishery, habitats need to be placed to allow those fish species to accomplish survival tasks.

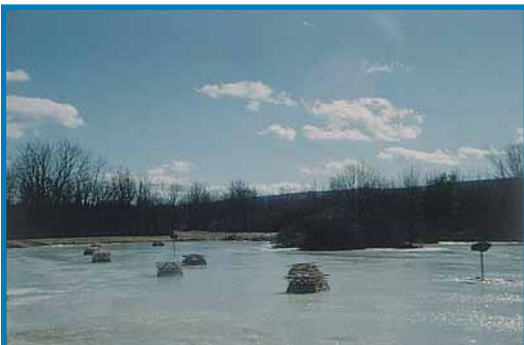

***Ponds require different construction and placement methods than reservoirs and lakes. These Porcupine Crib Jrs. have been constructed and placed on safe ice. When the ice melts, the cribs will fall to the pond bottom. This method is not generally used in reservoirs or lakes, due to the shifting of ice during spring breakup in these larger water bodies.***

In a pond that contains a bass/bluegill/bullhead/fathead minnow mix, all fish except the bullheads will directly benefit from the placement of appropriate structure within their environment. Bass will have more success at spawning, nesting and juvenile survival, if appropriate cover is present. Juvenile bluegill will have a better opportunity of recruiting to catchable size, if appropriate refuge cover is available. Fathead minnows, which are excellent forage for many species of gamefish, require specific overhead cover to spawn and naturally propagate.

Before placing artificial habitats in a pond, the owner should determine how he or she wishes to manage the pond. That is, what species and fish sizes are desirable for the owner and those who

will fish in the pond. Once that is determined, the correct artificial habitats can be constructed and added to the pond’s existing native and natural cover, providing habitat for the desired species and year-class size.

*If a typical pond contains a warmwater (bass, bluegill, bullhead, fathead minnow) fishery, habitats need to be placed to allow those fish species to accomplish survival tasks.*

# ACKNOWLEDGMENTS

In appreciation, I would like to acknowledge all the individuals who helped compile this data and review the drafts.

Chuck Burdowsky, U.S. Army Corps of Engineers  
Nathan Havens, PA Dept. of Environmental Protection  
Robert Hoskin, U.S. Army Corps of Engineers  
Steve Quinn, In-Fisherman Magazine  
Ryan Koch, Schuylkill County Conservation District  
Russell Maurer, DCNR/Bureau of State Parks  
Brent Pence, U.S. Forest Service  
William Reichert, PA B.A.S.S. Federation

John Arway, PA Fish & Boat Commission  
Scott Carney, PA Fish & Boat Commission  
Laurel Garlicki, PA Fish & Boat Commission  
Ed Gray, PA Fish & Boat Commission  
Mark Hartle, PA Fish & Boat Commission  
Robert Lorantas, PA Fish & Boat Commission  
Art Michaels, PA Fish & Boat Commission  
Sandy Norbeck, PA Fish & Boat Commission  
Leroy Young, PA Fish & Boat Commission

Special thanks to all the individuals that are cooperators and volunteers in the Fish & Boat Commission's Cooperative Adopt-a-Lake Program.



# APPENDICES

## PENNSYLVANIA ARTIFICIAL HABITAT STRUCTURE STANDARD DRAWINGS

### PENNSYLVANIA PORCUPINE CRIB STANDARD DRAWING REVISED VERSION

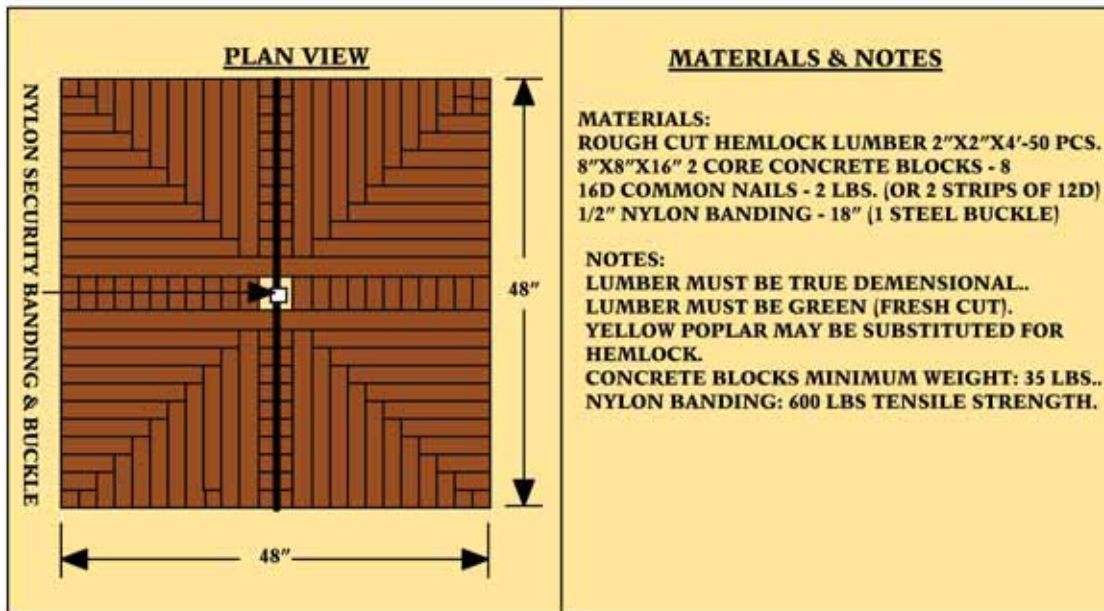
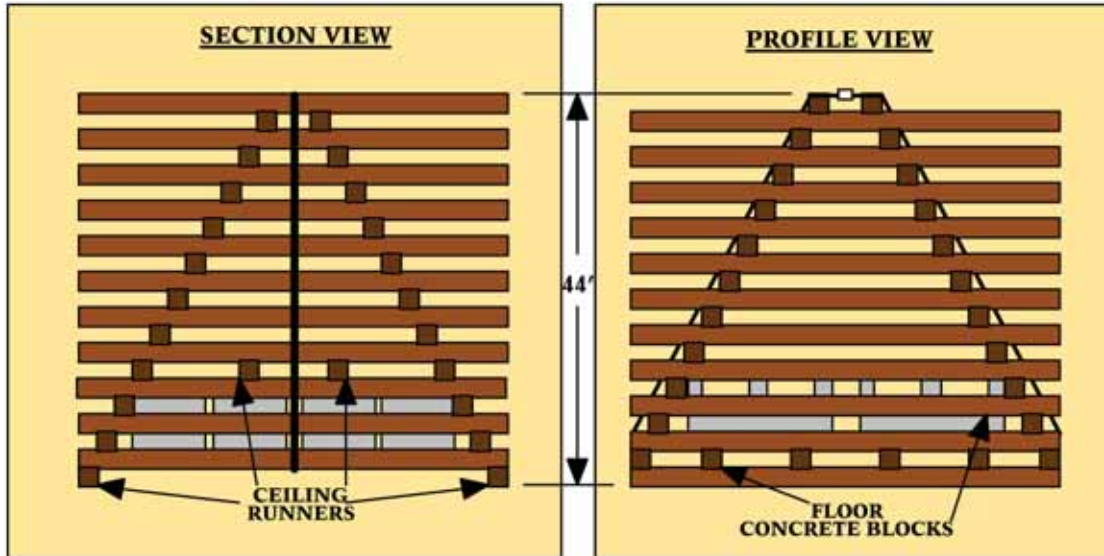

PFBC 11/497/REVISED 10/30/01

DFH 97

**PENNSYLVANIA PORCUPINE BRUSH CRIB  
PLACEMENT GUIDE FOR HILL-LAND IMPOUNDMENTS**

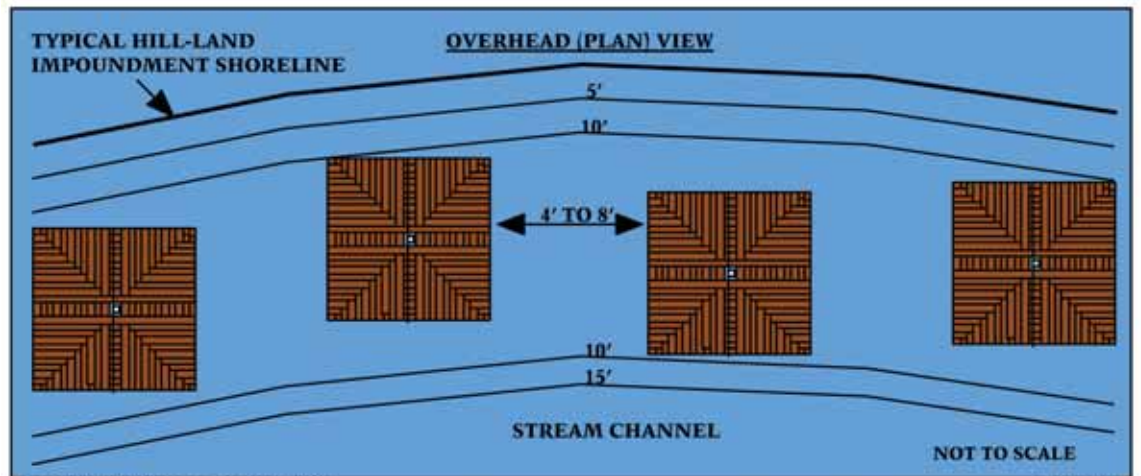
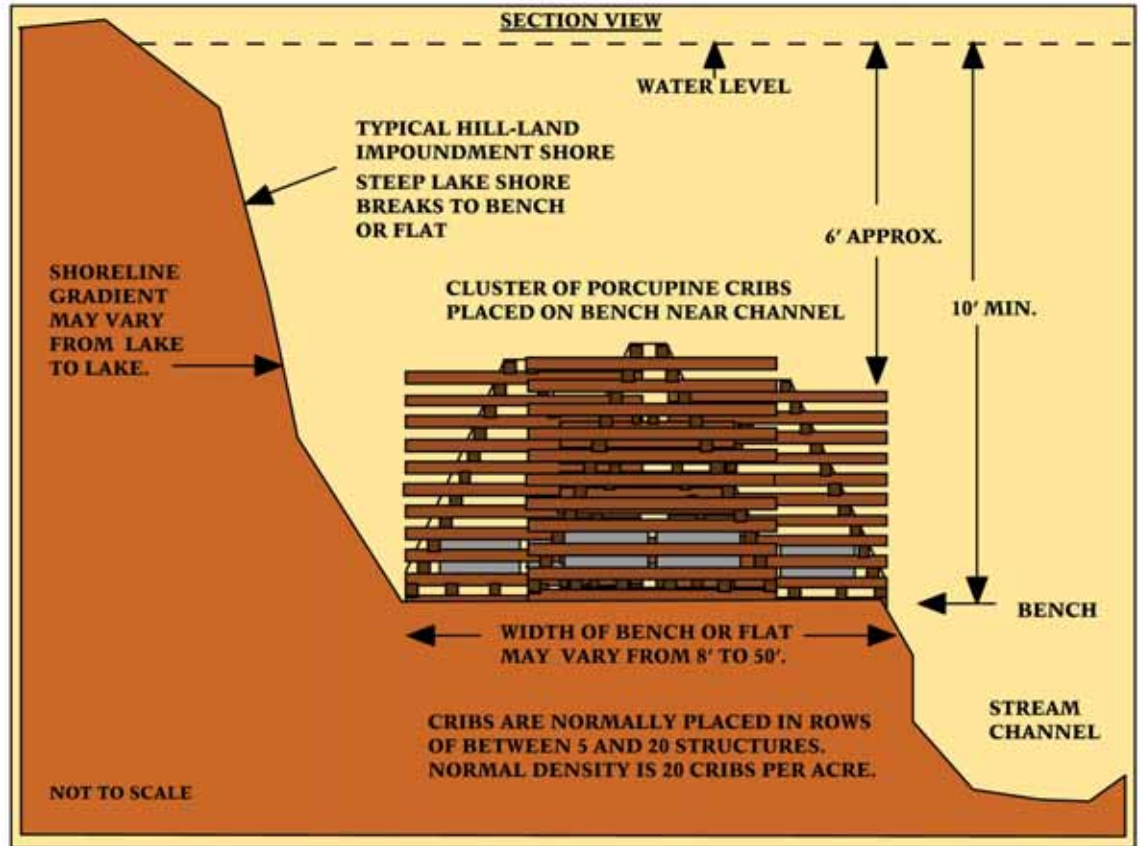

PFBC 1/022/99 REVISED 1/10/01

DFH 97

**PENNSYLVANIA PORCUPINE CRIB,  
STANDARD DRAWING**

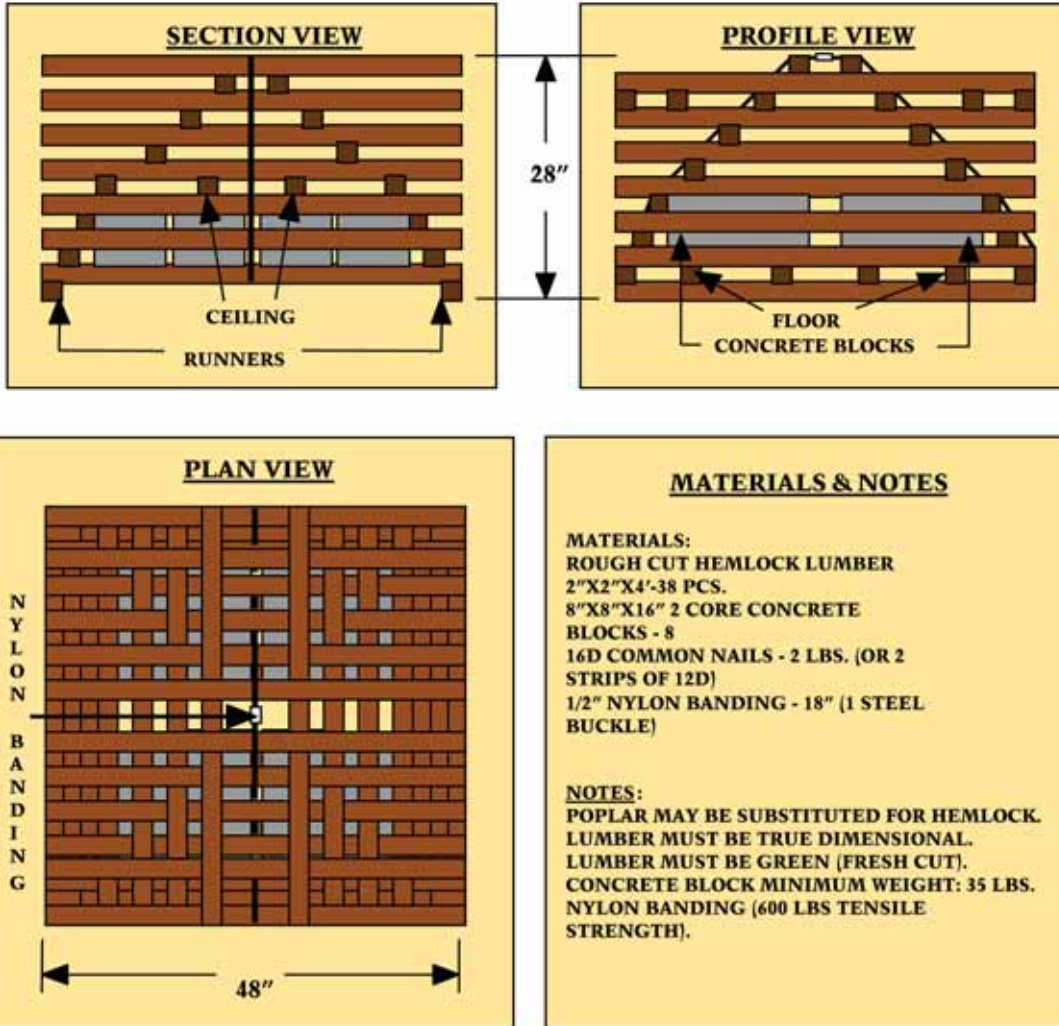

PFBC 10/08/97/REVISED 11/10/01

DFH 97

**PENNSYLVANIA PORCUPINE CRIB, JR.  
PLACEMENT GUIDE FOR HILL-LAND & FLATLAND IMPOUNDMENTS**

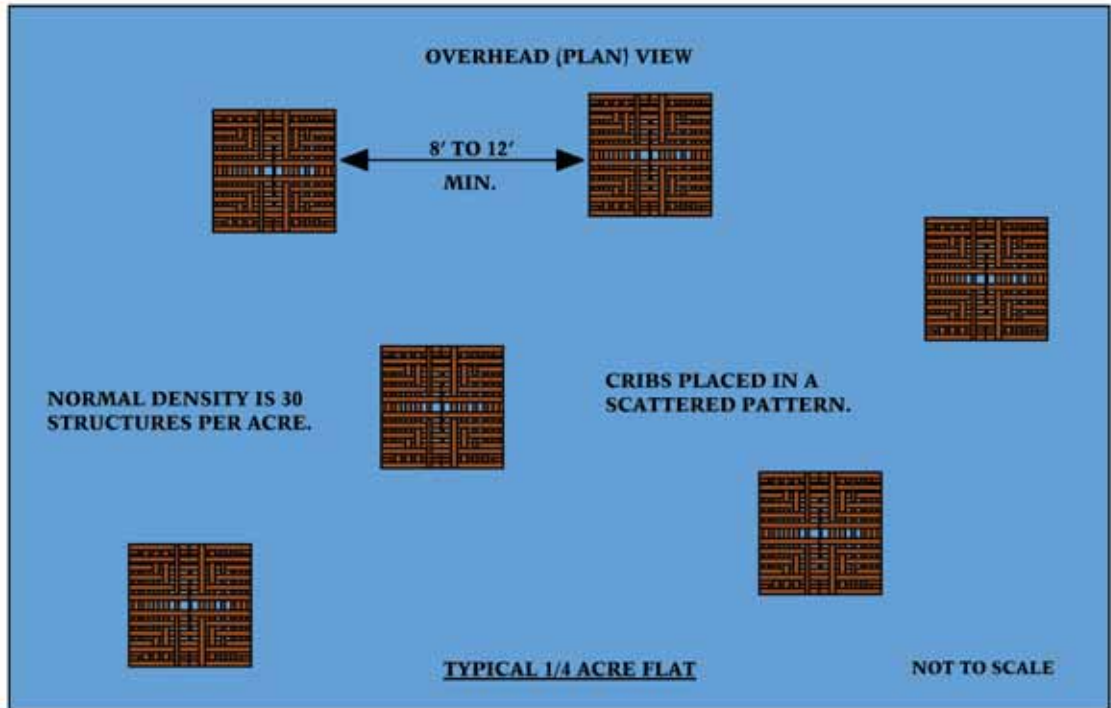
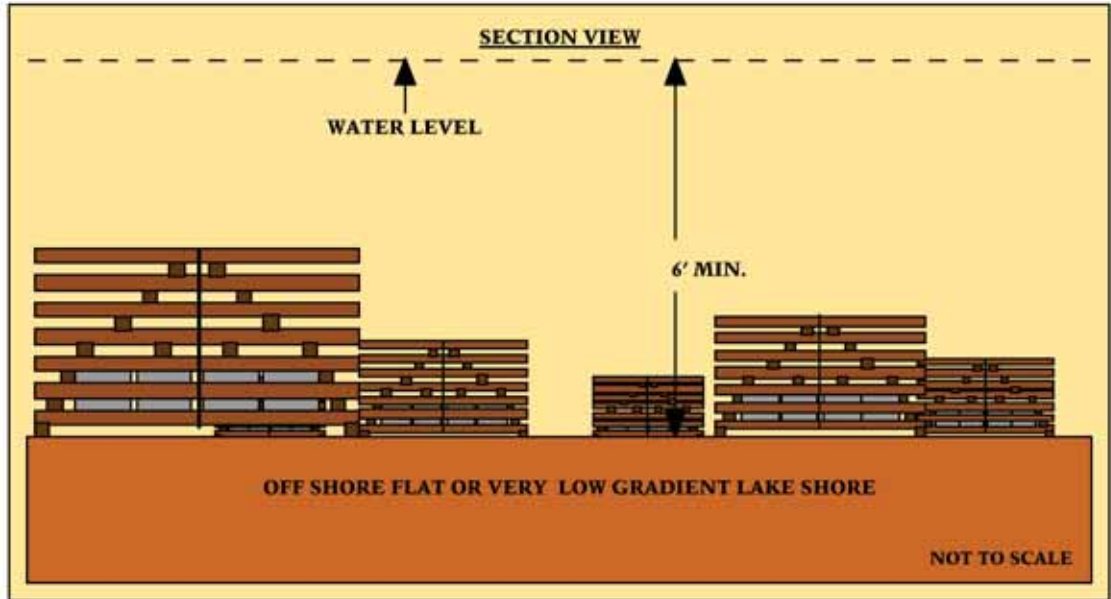

PFBC 1/2/98

DFH 97

**PENNSYLVANIA "SHORT" VERTICAL PLANK STRUCTURE  
S T A N D A R D D R A W I N G**

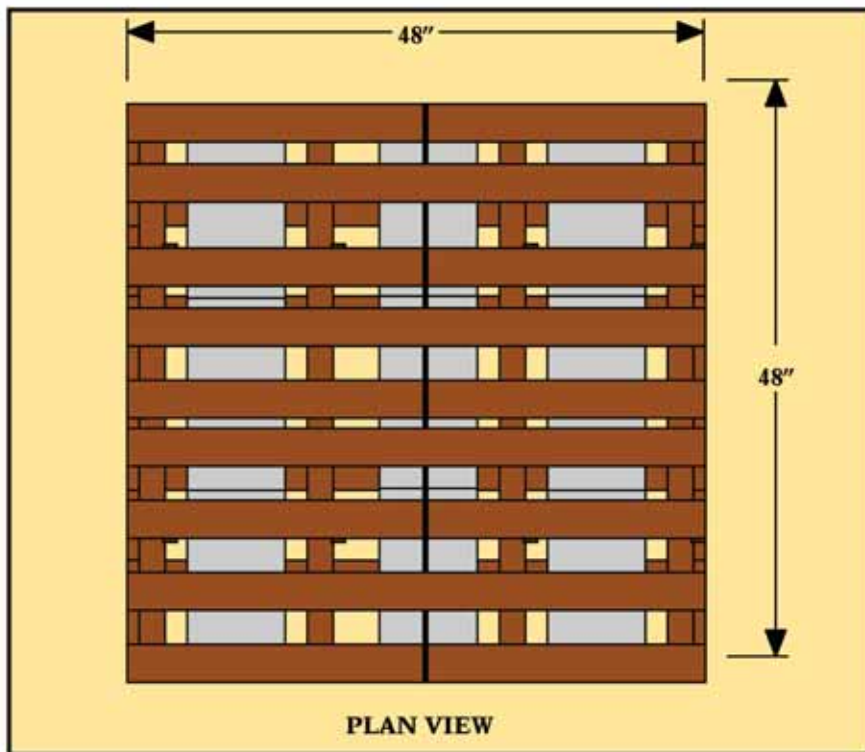
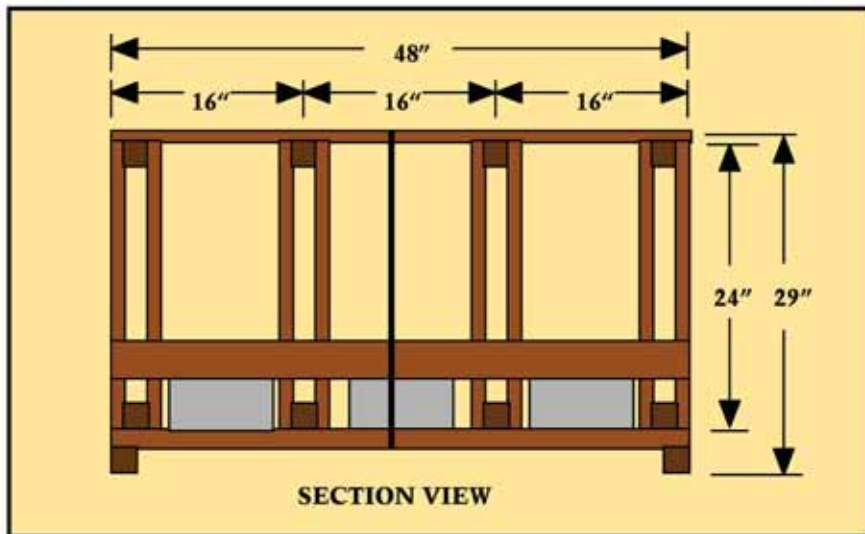

PFBC 3/26/02 REVISED 9/2/03

DFH 03

**P E N N S Y L V A N I A S H O R T V E R T I C A L P L A N K S T R U C T U R E  
P L A C E M E N T G U I D E F O R H I L L - L A N D & F L A T L A N D I M P O U N D M E N T S**

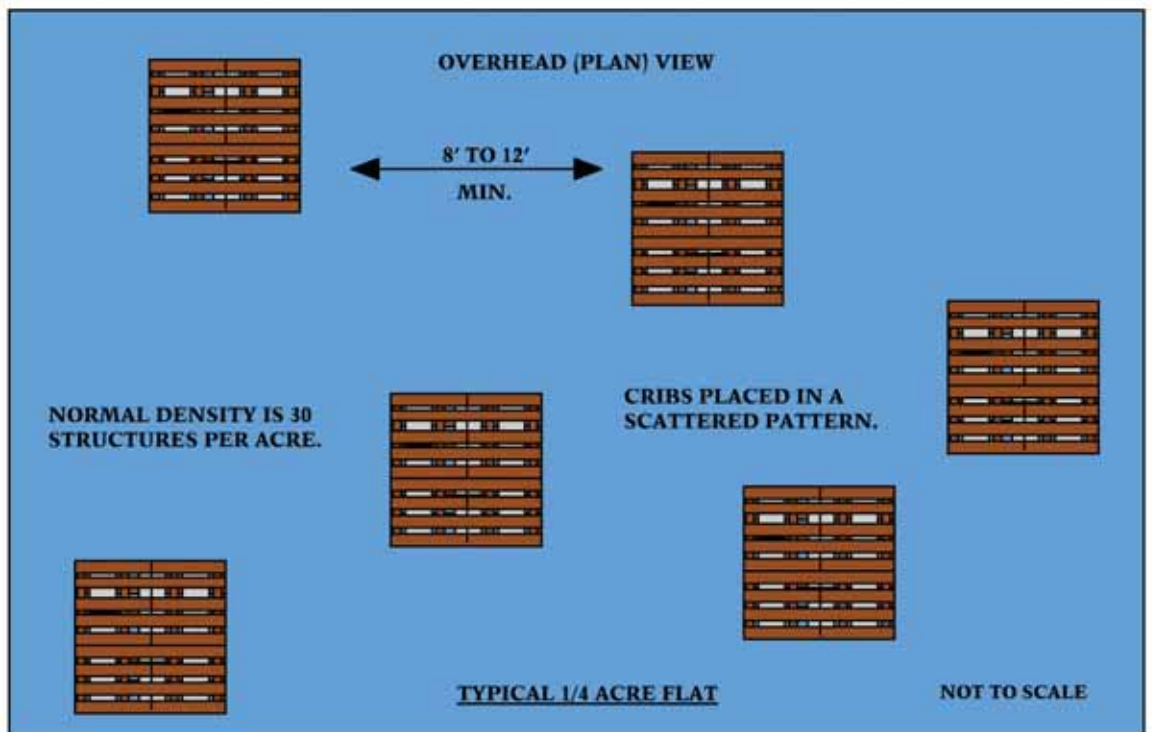
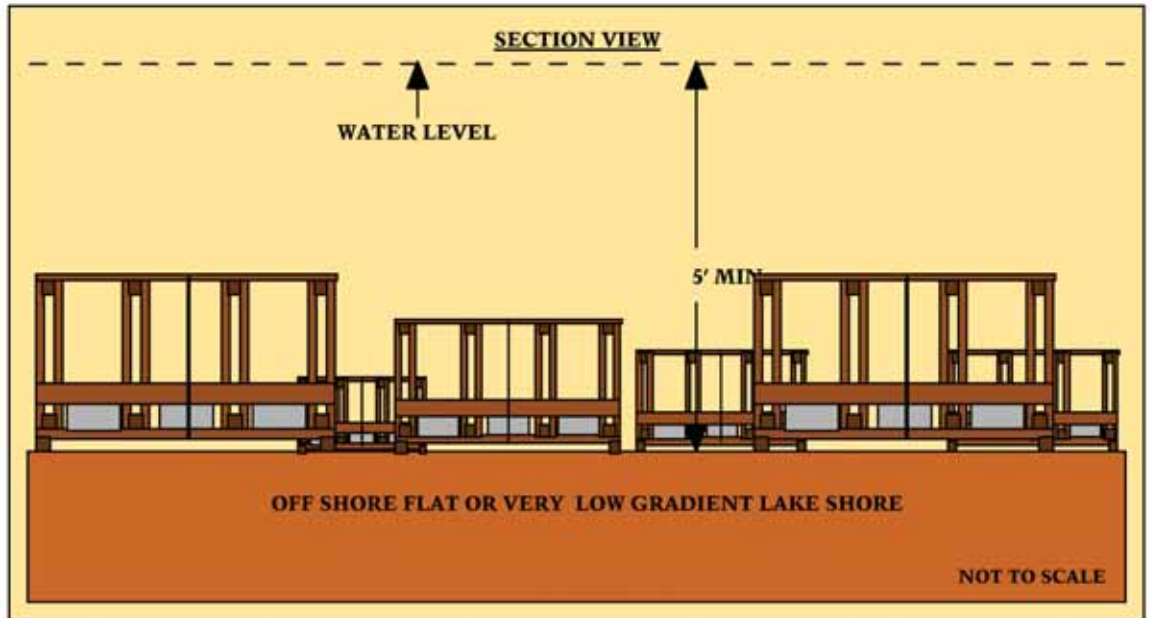

PFBC 8/19/03 REVISED 9/2/03

DFH 03



**PENNSYLVANIA STYLE  
FELLED SHORELINE TREE  
STANDARD DRAWING**

STUMP WITH SLOT CUT OR HOLE DRILLED THROUGH THE STUMP ALLOWS 1/4" GALVANIZED CABLE TO BE THREADED THROUGH THE STUMP.

LARGE HARDWOOD TREE FELLED INTO THE LAKE WITH SLOT CUT OR HOLE DRILLED THROUGH TRUNK ALLOWS THE END OF THE 1/4" GALVANIZED CABLE FROM THE STUMP TO BE THREADED THROUGH THE TRUNK.

CABLE IS WRAPPED AROUND BOTH TRUNK AND STUMP AND THEN SECURED WITH CABLE CLAMPS

WATER LEVEL

10'  
MIN.  
DEPTH

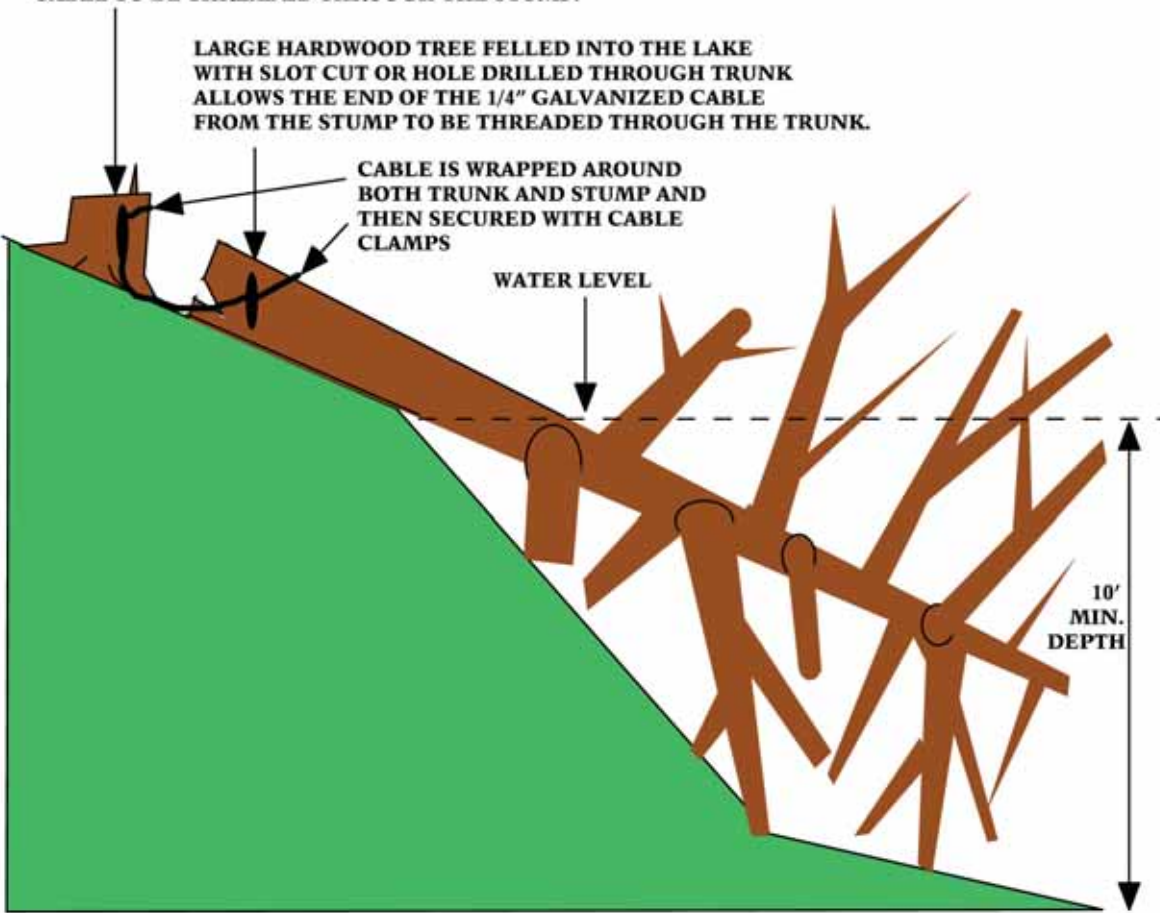

**MATERIALS:**

- 1 - LARGE SHORELINE HARDWOOD TREE (OAK)
- 20' - 1/4" GALVANIZED CABLE OR WIRE ROPE
- 2 - 1/4" CABLE CLAMPS (PINNED ONCE ATTACHED)

PFBC 12/17/97

DFH 97

**PENNSYLVANIA BLACK BASS NESTING STRUCTURE  
S T A N D A R D D R A W I N G**

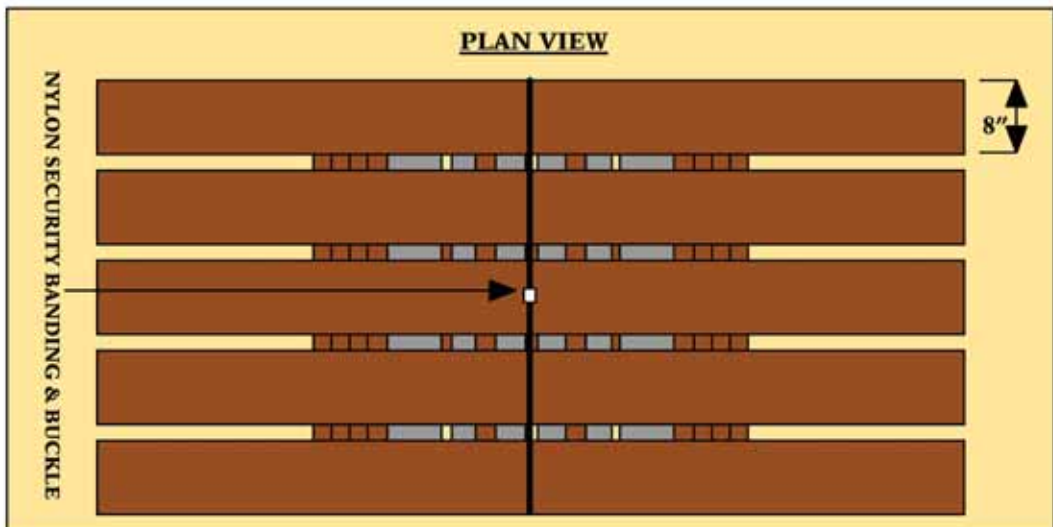
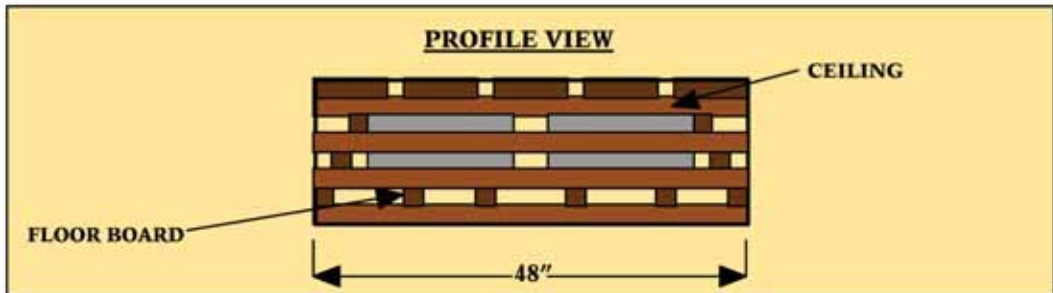
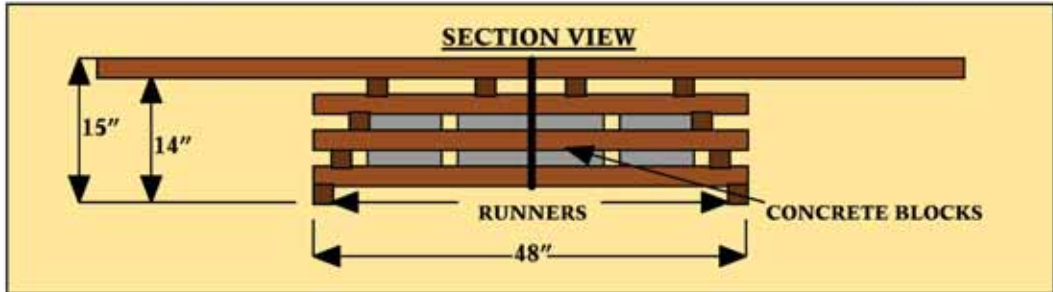

**MATERIALS & NOTES**

**NOTES:**  
 POPLAR MAY BE SUBSTITUTED FOR HEMLOCK.  
 LUMBER MUST BE GREEN (FRESH CUT)  
 LUMBER MUST BE TRUE DIMENSIONAL.  
 CONCRETE BLOCK MINIMUM WEIGHT: 35 LBS.  
 NYLON BANDING(600 LBS. TENSILE  
 STRENGTH.

PFBC 8/11/99/REVISED 11/23/99

DFH 97

**PENNSYLVANIA BLACK BASS NESTING STRUCTURE  
PLACEMENT GUIDE FOR IMPOUNDMENTS**

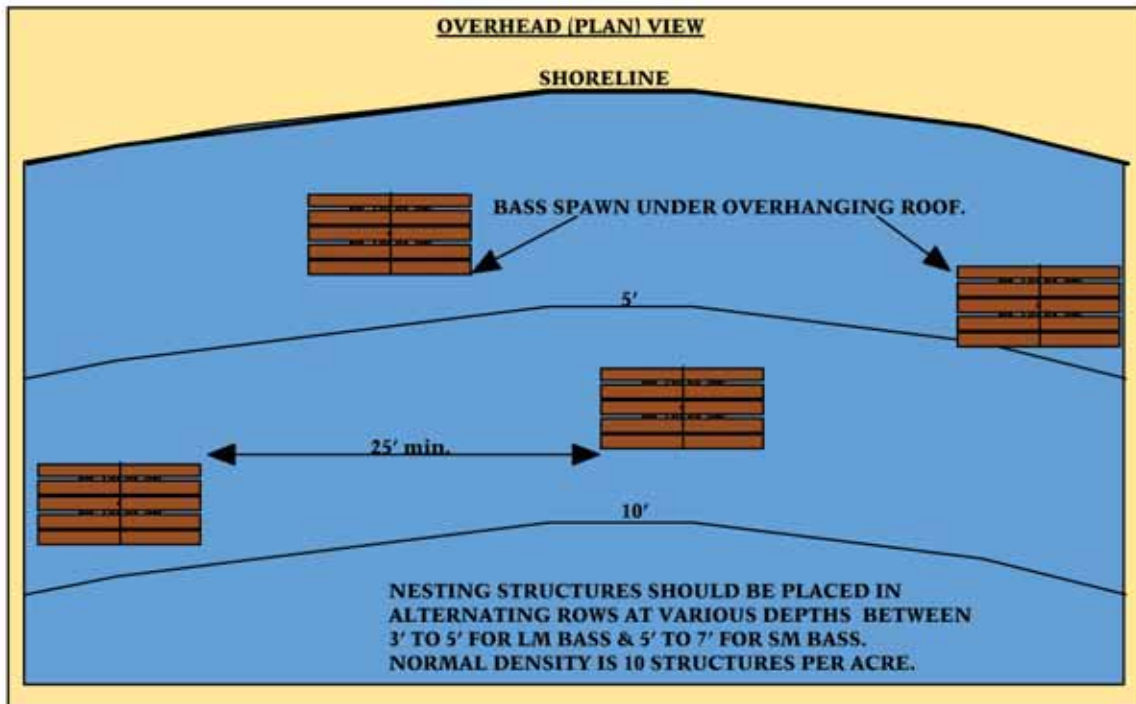
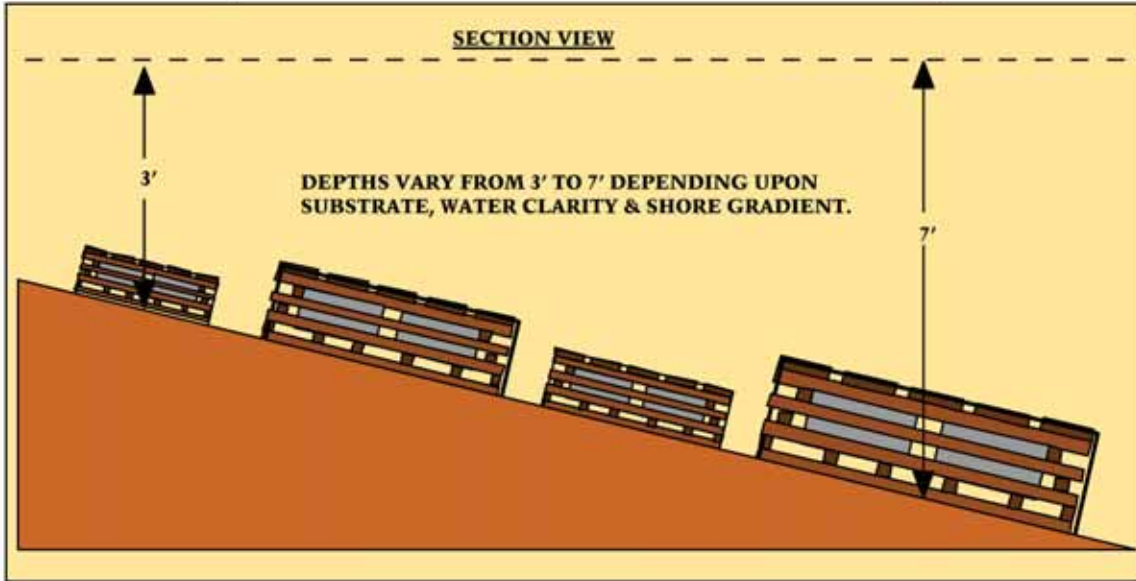

PFBC 1/2/98 REVISED 1/10/01

DFH98

**PENNSYLVANIA CHANNEL CATFISH SPAWNING BOX  
STANDARD DRAWING**

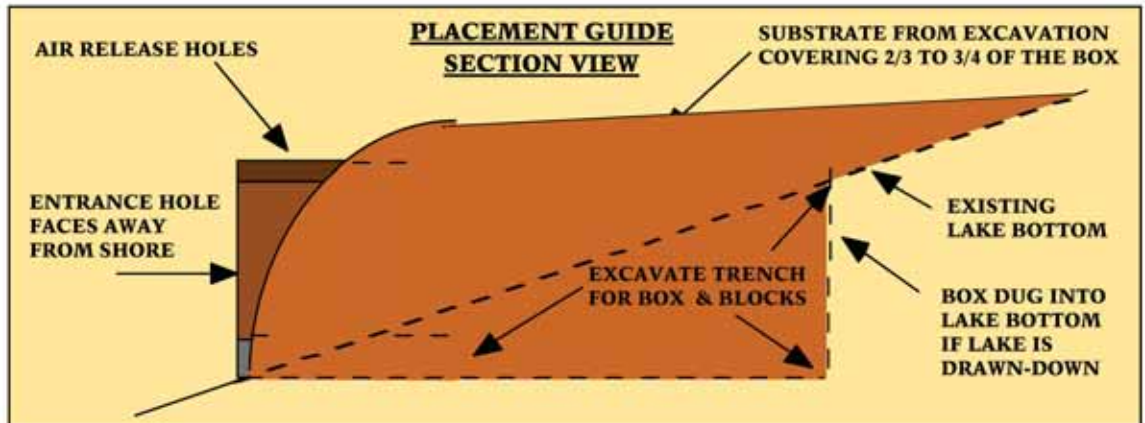
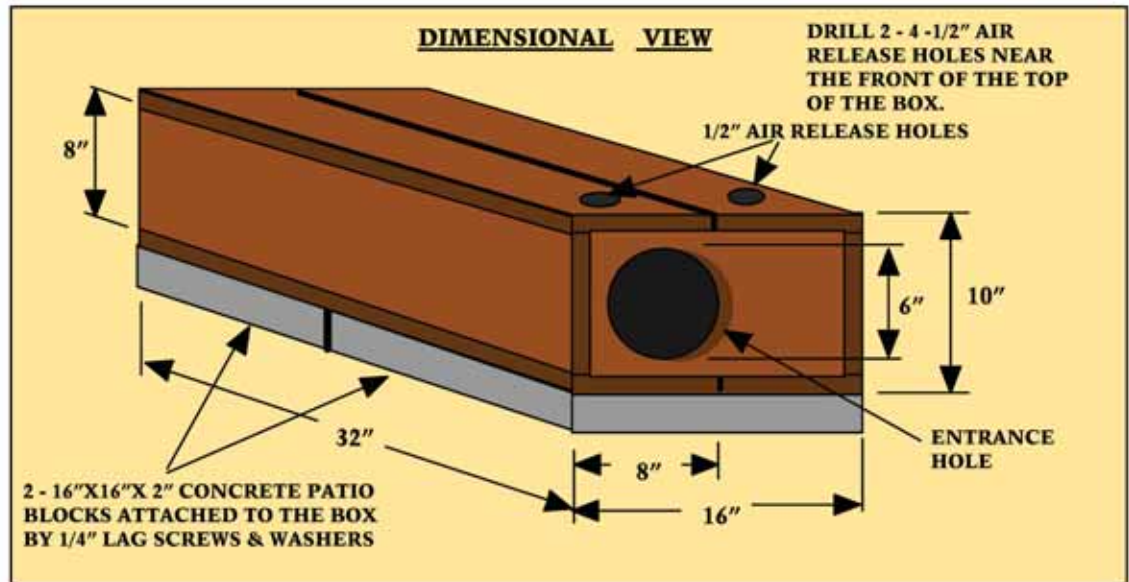

**MATERIALS (PER ONE BOX):**  
 1"X8"X8' ROUGH CUT HEMLOCK = 2.5 PCS.  
 16"X16"X2" CONCRETE PATIO BLOCKS = 2 EA.  
 10D COMMON NAILS; 32 NAILS OR 1/8TH LBS.  
 1/4" LAG SCREW & WASHERS: 4 EA.

**SUGGESTED EQUIPMENT:**  
 ELECTRIC DRILL, SABER SAW, CIRCULAR SAW  
 7/16" SOCKET & RATCHET, CLAW HAMMER  
 1/4" MASONRY BIT, 1/2" WOOD BIT.

**NOTES:**  
 THE BOX SHOULD BE PLACED IN 3' TO 6' DEPTHS WITH THE OPENING FACING AWAY FROM SHORE.

THE BOX MAY ALSO BE PLACED DURING "FULL POOL" PERIODS, BY GENTLY SUBMERGING THE BOX FROM A WATERCRAFT AND LETTING THE BOX REST DIRECTLY ON THE BOTTOM OF THE LAKE, WITH NO EXCAVATION OF SUBSTRATE NECESSARY.

PFBC 10/22/99

DFH 97

**FATHEAD MINNOW SPAWNING COVER  
STANDARD DRAWING**

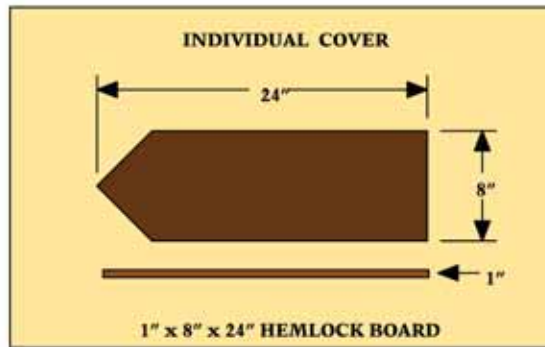
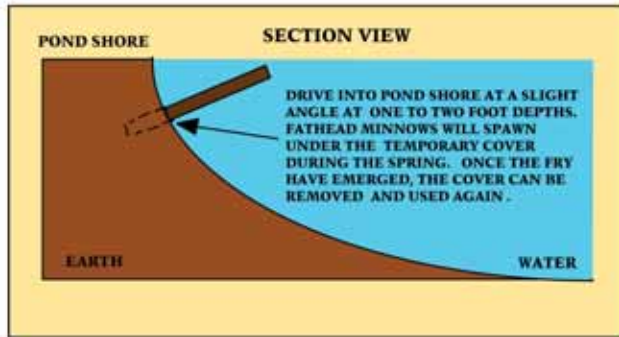

**NOTES:**  
DENSITY: 6 COVERS PER ACRE.  
POINT END OF BOARD TO DRIVE INTO EARTH.  
DRIVE POINTED END 3" TO 6" INTO THE SHORE.  
SPAWNING SEASON OCCURS FROM MAY TO JUNE.

PFBC 10/20/99

DFH 99

**PENNSYLVANIA STYLE ROCK RUBBLE REEFS  
S T A N D A R D D R A W I N G**

**PROFILE DRAWING**



**MATERIALS:  
2.5 TO 7.5 TONS OF LIMESTONE SHOT ROCK OR NATIVE  
STONE**

**DIMENSIONAL VIEW**

**ROCK RUBBLE HUMPS ARE PLACED IN A RANDOM PATTERN.**

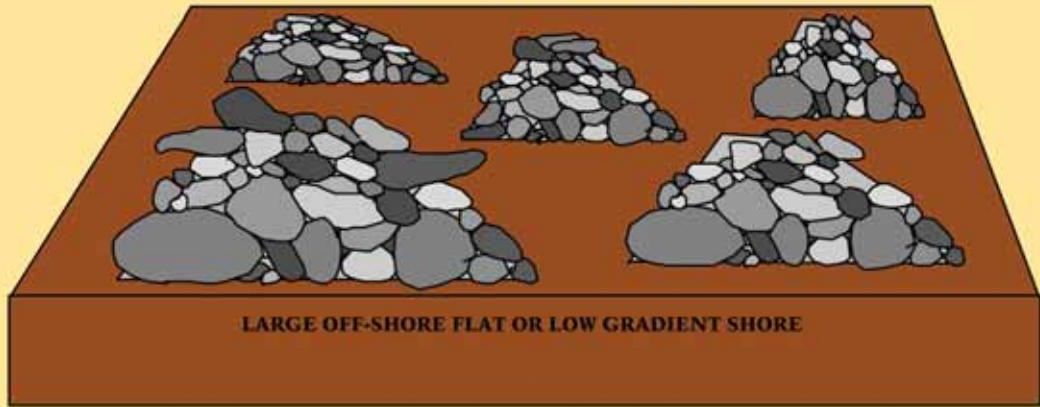

**NORMAL DENSITY IS 107.5 TON HUMPS PER ACRE (75 TONS/ACRE).**

**NOT TO SCALE**

**PENNSYLVANIA STYLE RUBBLE HUMPS  
S T A N D A R D D R A W I N G**

**PROFILE VIEW**



**RUBBLE HUMPS PLACED ON FLAT OR GRADUALLY SLOPED SHORE  
NORMAL DENSITY IS 20 2-TON HUMPS PER ACRE (40 TONS/ACRE).**

**SECTION VIEW  
INDIVIDUAL HUMPS**

**1 TO 2 TONS OF #4 AND/OR #5 SANSTONE OR LIMESTONE ROCK**



**LAKE BOTTOM**

**PFBC 12/28/00/REVISED 12/20/01**

**DFH 00**

**PENNSYLVANIA TURTLE BASKING PLATFORM**  
**WITH PVC FLOATS FOR STABLE POOL IMPOUNDMENTS & PONDS**  
**S T A N D A R D D R A W I N G**

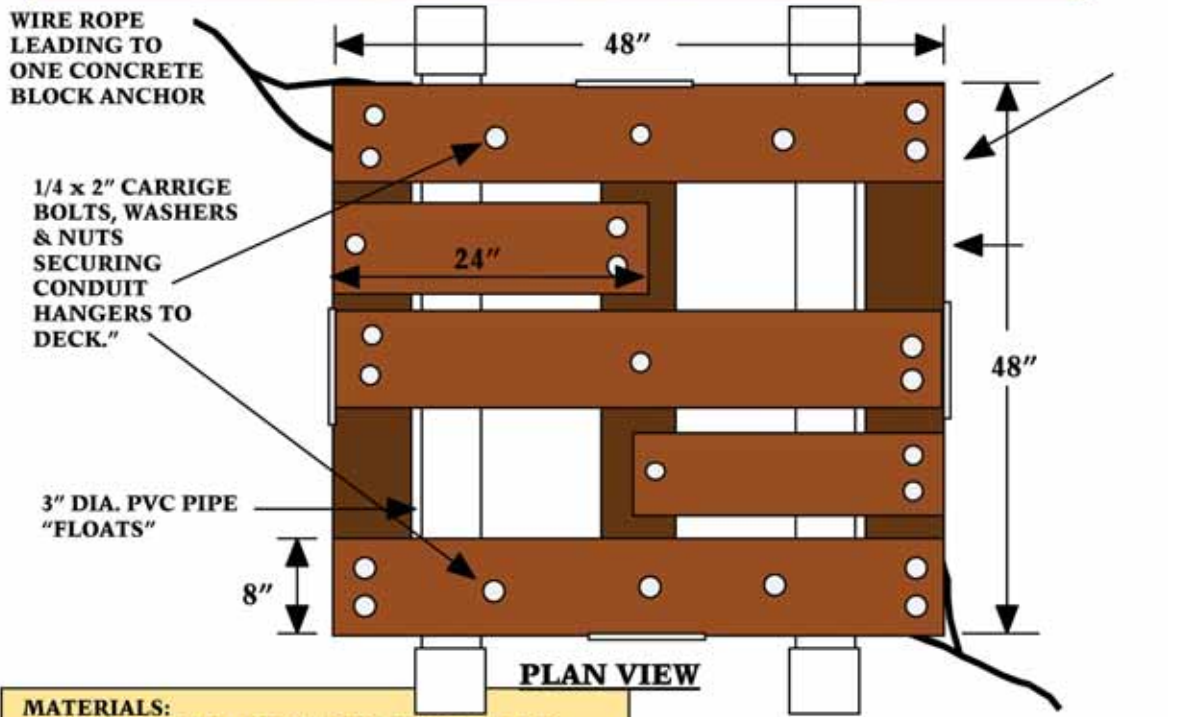

- MATERIALS:**  
 1"X8" ROUGH CUT HEMLOCK LUMBER: 16 LN.  
 4"X4" ROUGH CUT HEMLOCK LUMBER: 12 LN.  
 #10 X 3" FLATHEAD GALVINIZED SCREWS: 25  
 #10 X 3" WASHERHEAD GALVINIZED SCREWS: 8  
 1/2" x 2" CARRIGE BOLTS AND NUTS: 4  
 CONCRETE BLOCKS: 2-8"(MIN. WEIGHT 35 LBS  
 1/4" STAINLESS STEELWIRE ROPE: 20' (2 -10'  
 1/4" STAINLESS STEEL CABLE CLAMPS:  
 3" DIA. SCHEDULE 40 PVC PIPE: 10' (2 - 60"  
 3" DIA. PVC END CAPS:  
 3" CONDUIT HANGERS:  
 PFBC HABITAT ENHANCEMENT SIGNS:  
 PVC PIPE CEMENT AND CLEANER:

TWO #10 x3" SCREWS. SECURE EACH SIGN TO THE PLATFORM. PFBC HABITAT ENHANCEMENT STRUCTURE SIGNS

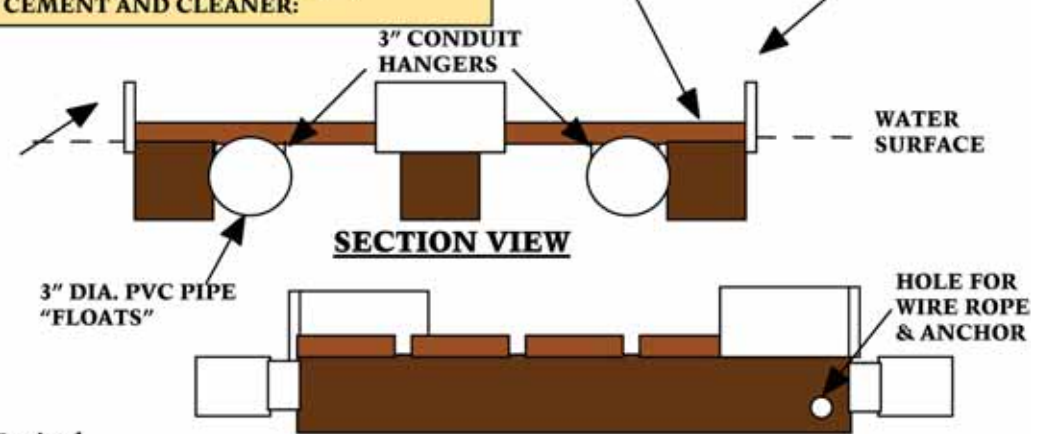

PFBC 7/7/05/Revised

DFH 05



# TYPICAL PENNSYLVANIA POND FISH HABITAT PLAN

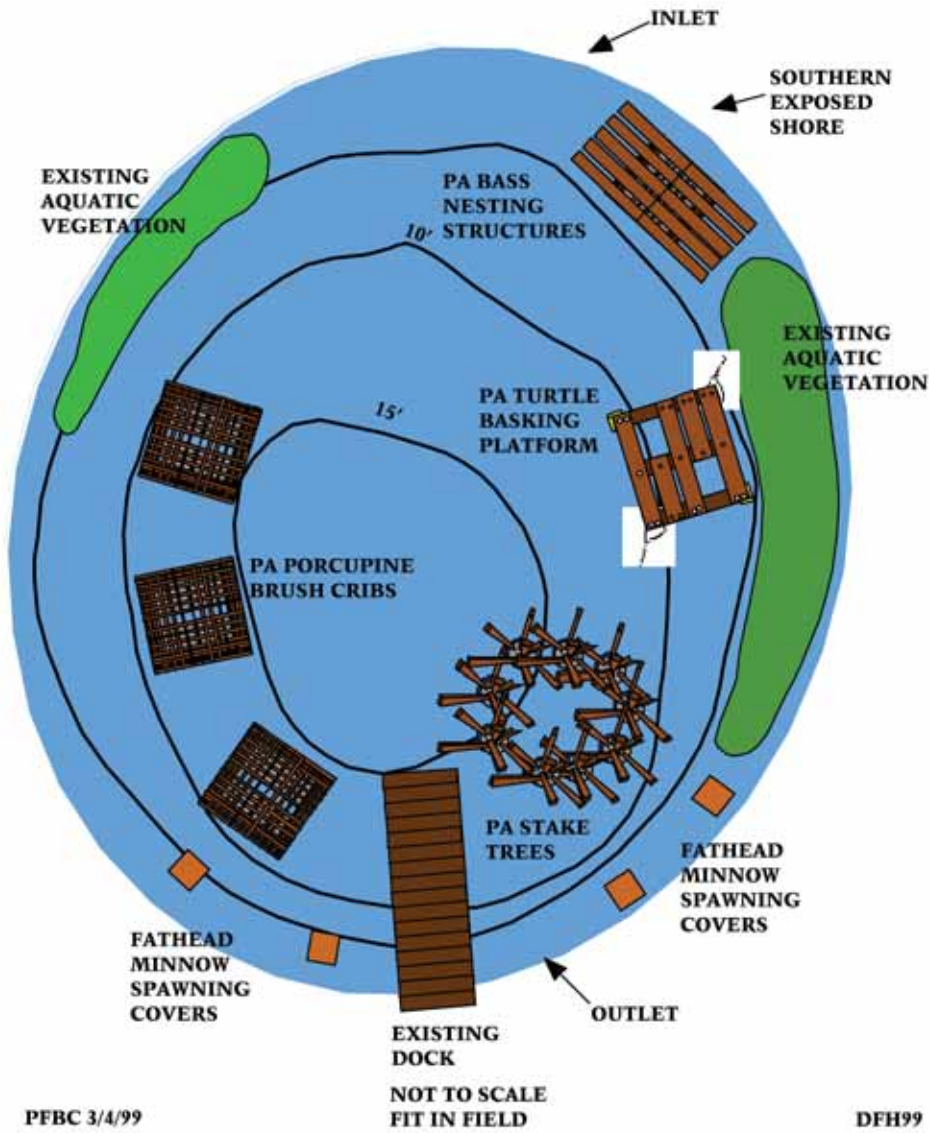

## RESEARCH LITERATURE

- Angermeier, P.L., and J.R. Karr. Relationship between woody debris and fish habitat in a small warmwater stream, *Transactions of the American Fisheries Society* 113: 716-726.
- Barwick, R.D., Kwak, T.J., "Fish Populations Associated with Habitat-Modified Piers and Natural Woody Debris in Piedmont Carolina Reservoirs," *North American Journal of Fisheries Management* 24:1120-1133, American Fisheries Society, 2004.
- Benke, A.C., T.C. Van Aardsall, Jr., D.M. Gillespie and F.K. Parrish, 1984. Invertebrate productivity in a subtropical blackwater river: the importance of habitat and life history, *Ecological Monographs* 54: 25-63.
- Benson, B.J. and J.J. Magunson, "Spatialheterogeneity of Littoral Fish Assemblages in Lakes: Relation to Species Diversity and Habitat Structure." *Canadian Journal of Fisheries and Aquatic Sciences*, 1992.
- Bozek, M.A. "A Second Life for Trees in Lakes." *Lakeline Magazine*, 2001.
- Bryant, G.J. "Direct Observations of Largemouth and Smallmouth Bass in Response to Various Brush Structure Designs in Ruth Reservoir, California." *FHR Currents*, Number 10, October 1992.
- Busch, L. Robert. "Evaluation of Three Spawning Containers for Channel Catfish." *Prog. Fish-Cult.*, April 1983.
- Glass, N.R. Computer Analysis of Predator Energetics in the Largemouth Bass. Pages 325-363 in *B. C. Pattern*, 1971.
- Hall, D.J., and E.E. Werner, 1977. Seasonal distribution of fishes in the littoral zone of a Michigan lake. *Transactions of the American Fisheries Society* 106:545-555.
- Hoff, M.H. "Effects of Increased Nesting Cover on Nesting and Reproduction of Smallmouth Bass in a Northern Wisconsin Lake." Mississippi State University, 1991.
- Hunt, J., Annett, C.A. "Effects of Habitat Manipulations on Reproductive Success of individual Largemouth Bass in an Ozark Reservoir," *North American Journal of Fisheries Management*, American Fisheries Society, 2002.
- Jackson, J.R., Noble, R.L., Irwin, E.R., Van Horn, S.L. "Response of Juvenile Largemouth Bass to Habitat Enhancement through Addition of Artificial Substrates," Proc. Annual Conference, SEAFWA, 2000.
- Lalo J., Houser, D.F. "Fish Habitat Improvement for Lakes, Ponds and Reservoirs," Pennsylvania Fish & Boat Commission, 1982.
- Linder, A. "The Secret Teachings of Angling Wisdom & Knowledge," *In-Fisherman, Inc.*, Brainerd Minnesota, 1987.
- Lynch, W.E., Johnson, D.L., Kayle, K.A. "Effects of Deep to Shallow Water Row on Fish Use of Artificial Structure," Ohio State University, 1988.
- Lynch, W.E., Johnson, D. L., Durfey, L. E. "Importance of Depth as an Artificial Structure Placement Factor," Ohio State University, 1988.
- Lynch, W.E., Kayle, A.K., Johnson, D.L. "Importance of Bottom Gradient as an Artificial Structure Placement Factor," Ohio State University, 1988.
- Martin, T.H., Philips, C. "An Evaluation of Artificial-Spawning-Structure Use by Largemouth Bass in Blue Marsh and Lake Marburg, Pennsylvania." Penn State University, School of Forest Resources, 1998.
- Nilsen, H.C and R.W. Larimore, 1973. Establishment of invertebrate communities on log substrates in the Kaskaskis River, Illinois, *Ecology*.
- Savino, J.F. and R.A. Stein, 1982. Predator-prey interaction between largemouth bass and bluegills as influenced by simulated, submerged vegetation, *Transactions of the American Fisheries Society* 111: 255-266.
- Wege, G. J., Anderson, R.O. "Influence of artificial structures on largemouth bass and bluegill in small ponds," Johnson and Stein, 1979.
- Werner, E.E., J.F. Gilliam, D.J. Hall and G.G. Mittelbach, 1983. An experimental test on the effects of predation of risk on habitat use in fish. *Ecology* 64: 1540-1548

## HABITAT CLASSIFICATION FOR PENNSYLVANIA IMPOUNDMENTS

	IMPOUNDMENT CLASSIFICATION			
	FLATLAND	HILL-LAND	HIGHLAND	CANYON
<b>WATER DEPTH</b>	20' to 35' at dam breast	30' to 50' at dam breast	50' to 200' at dam breast	50' to 100' at dam breast
<b>MAIN CHANNEL CHARACTERISTICS</b>	Seldom near shore, sinuous rather than meandering. Remains in the center of the reservoir. Not well defined.	Meandering rather than sinuous. Has long slow meanders and touches both in the main lake. Well defined with structure.	Large stream or river with well-defined meandering channel. The main channel is located in the center of the impoundment for the most part.	Large stream or river with well-defined sinuous channel.
<b>FEEDER STREAMS</b>	Normally few and less than 20-foot-wide channels. May be non-distinct.	Normally a feeder stream in every major bay. Small, distinct channels.	Normally few feeders. Small in comparison to the main tributary. Very distinct, with high banks and sinuous channels.	One or two feeders, if any at all.
<b>COVES AND BAYS</b>	Very few bays. Coves are small, short and shallow.	Scattered major bays, with few coves. Bays are large and contain feeder streams.	Normally few bays. Coves and bays are deep and long, with sharp and rocky points.	None or very few bays or coves.
<b>SHORELINE POINTS</b>	Broad and rounded. Slow tapering onto flats.	Gradual and rounded points, with high gradient shores leading to channels.	Points are sharp, steep and normally lead into stream or river channels.	Points are rounded and usually steep.
<b>SHORELINE FEATURES</b>	Mainly long, low gradient; slowly tapering shores on both sides.	Shores near major channels are normally steep, breaking onto benches. Opposing shores are normally slow tapered, leading onto flats.	Moderate to steep to cliffs. May have "stair-step" ledges. Shores normally break onto deep-water flats or channels. Impoundment shore follows the main channel's meandering pattern.	Moderate to steep, with opposing shore gradual.
<b>OFFSHORE FEATURES</b>	Shallow humps, submerged and emergent islands with large, extensive flats.	Few if any islands, humps or reefs. Roadbeds and channel intersections are typical offshore features.	Some emergent islands. Normally contains some reefs, but few, if any, humps. Primarily short, deep-water flats, leading to stream or river channels.	No islands, humps or reefs. May contain some flats.
<b>MANMADE FEATURES</b>	Long dam breast, causeways and extensive rip-rap.	Long to medium dam breast. Submerged building foundations and roadbeds are common. May have short causeways.	Short dam breast. Some roadbeds and bridges, but, overall, few manmade features, due to confines of shoreline features.	Narrow dam breast. Few manmade features.

Reservoirs must be at least 100 acres in size to be classified.

Pennsylvania Fish & Boat Commission, Habitat Management Section  
Adapted from The In-Fisherman's Comparative Impoundment Characteristics



[www.fish.state.pa.us](http://www.fish.state.pa.us)